

HUGO WEST INTERIORS

EXTERIOR PALLET

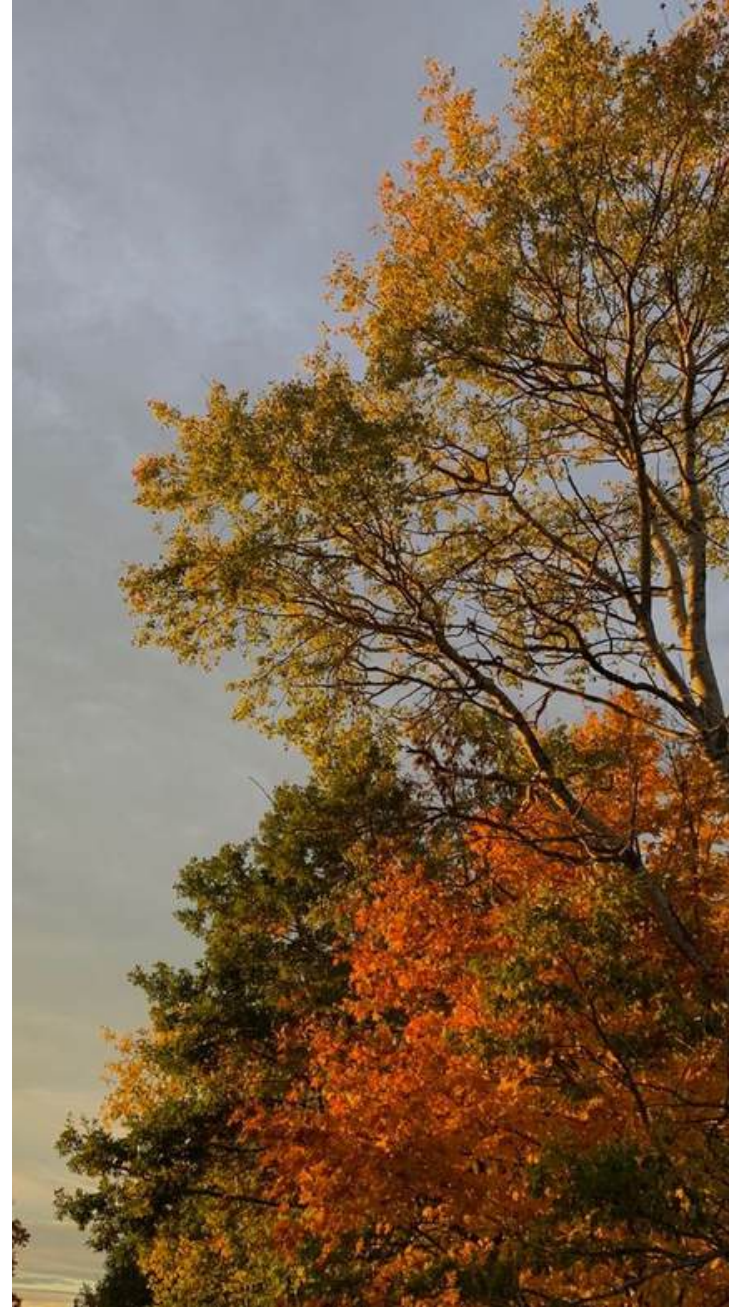

CONCEPT BOARD



MOOD BOARD



OVERALL PAINT COLORS

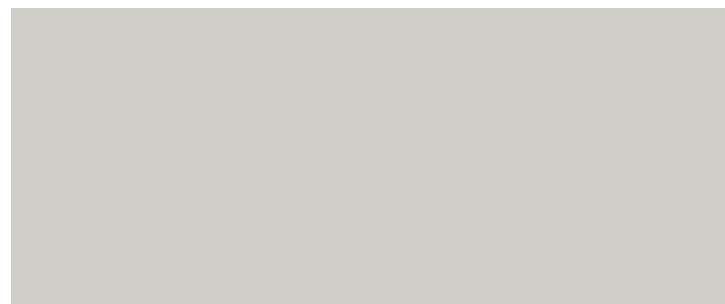
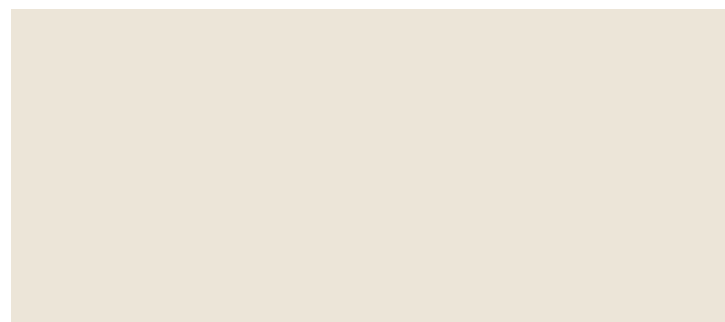

LOBBY FLOOR FINISHES

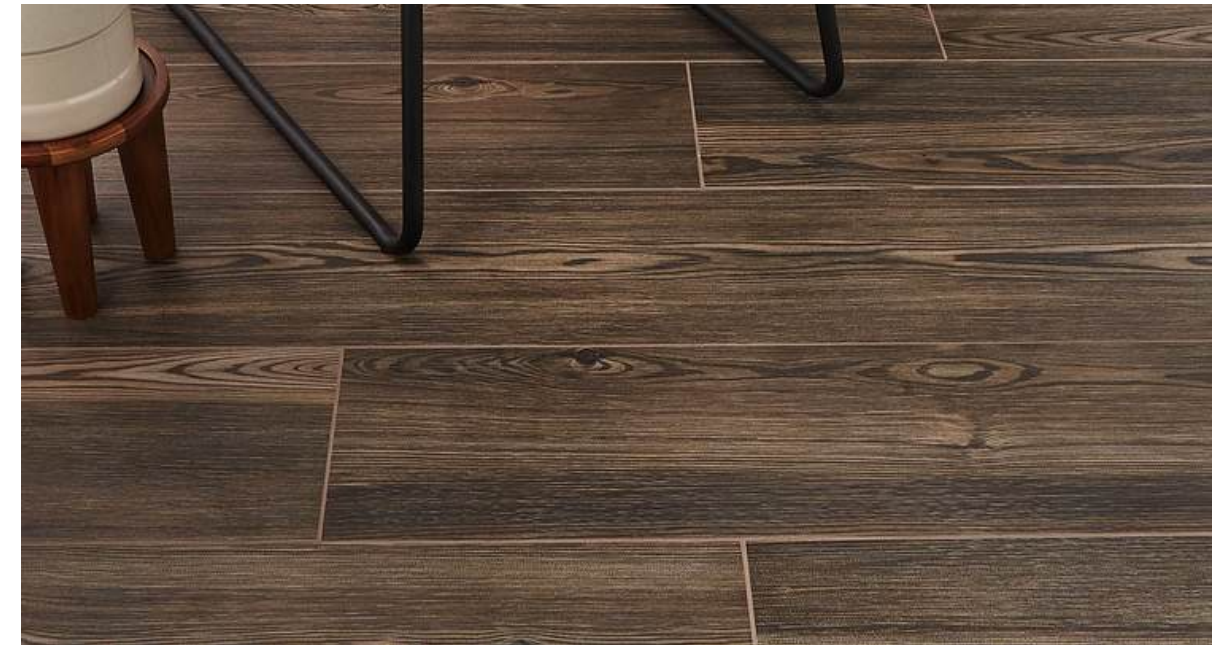
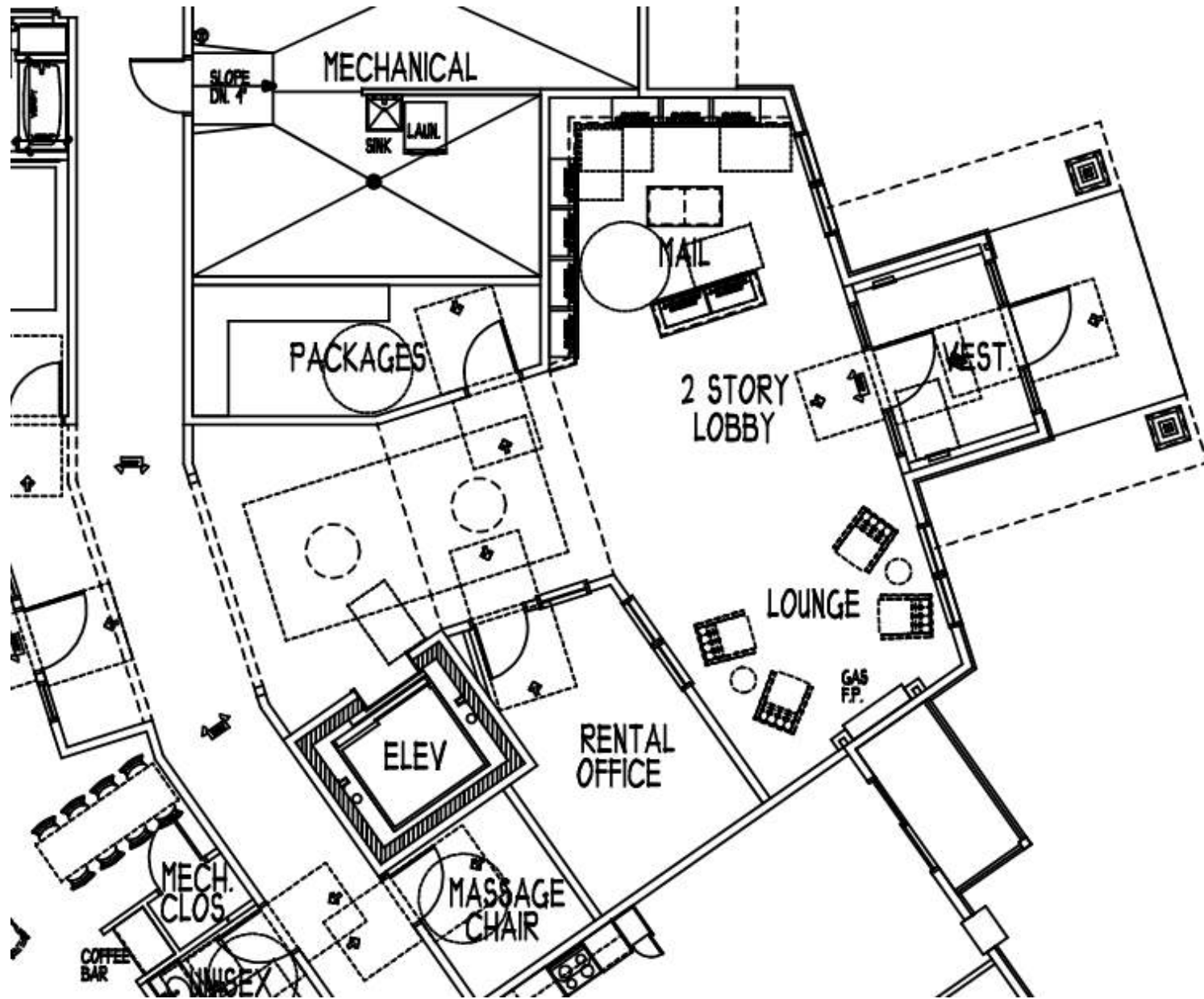

LOBBY FURNITURE



LOBBY FURNITURE PLAN 2

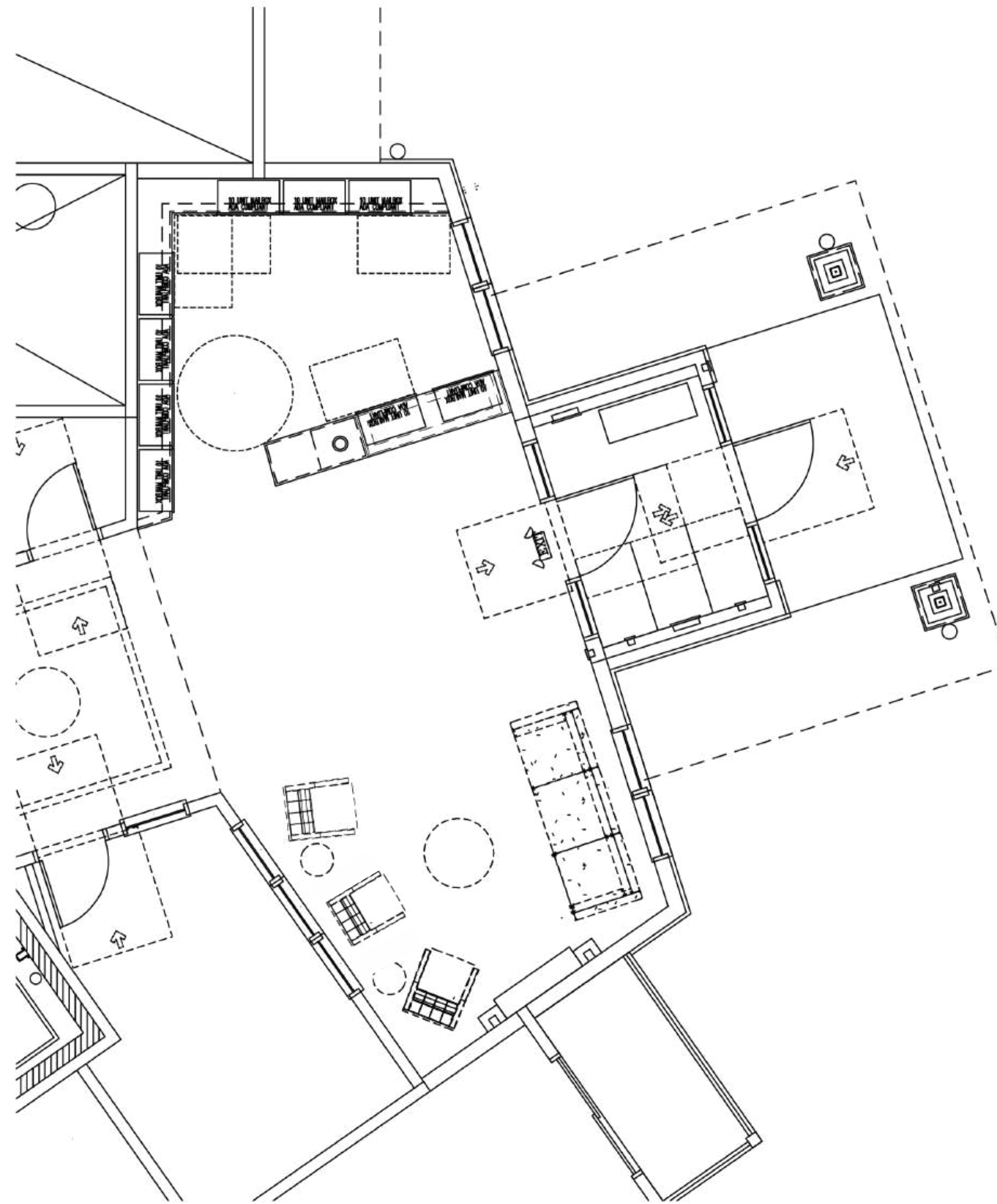

LOBBY FEATURE WALL

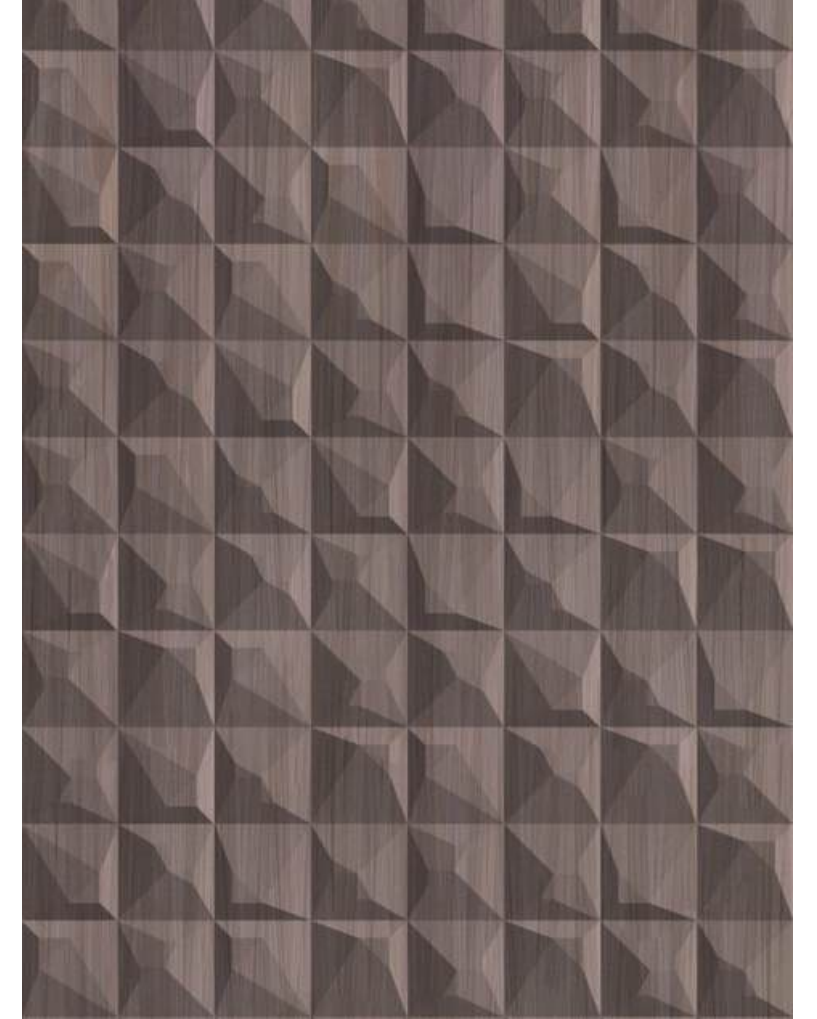
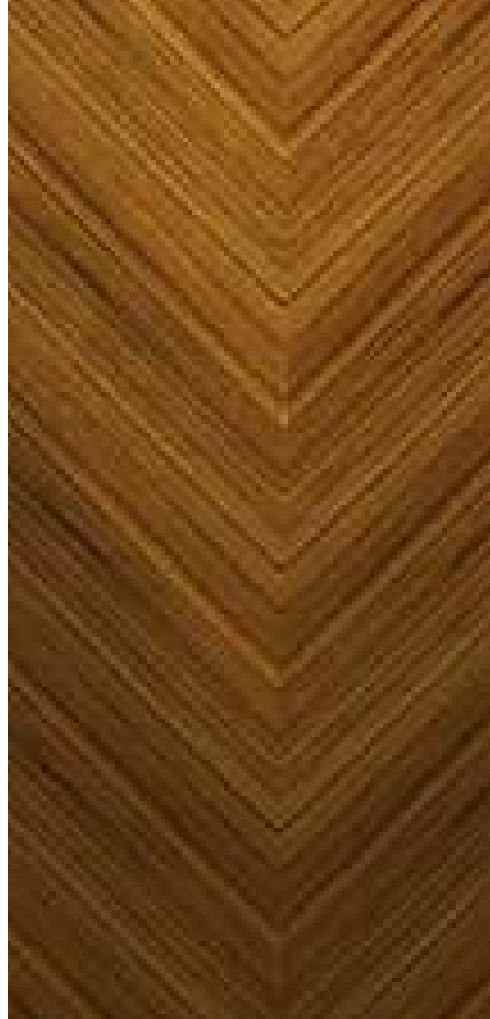
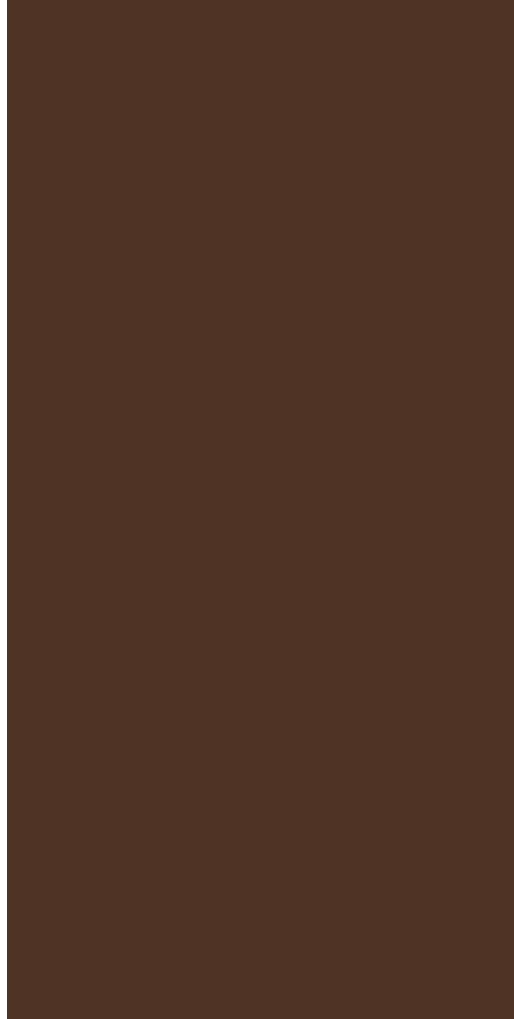

LOBBY FEATURE WALL OPTION 2 RENDERING



PAINTED PT-4, 3" x 1' BUMP OUTS



PAINTED PT-4, 3" x 1' BUMP OUTS

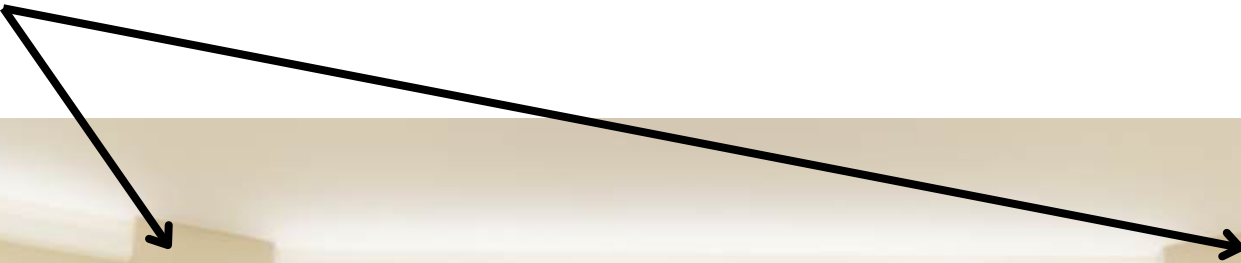

MAILROOM

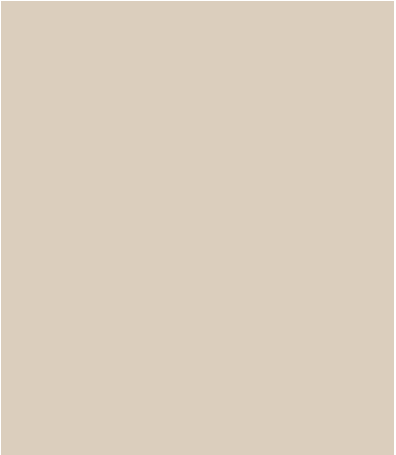
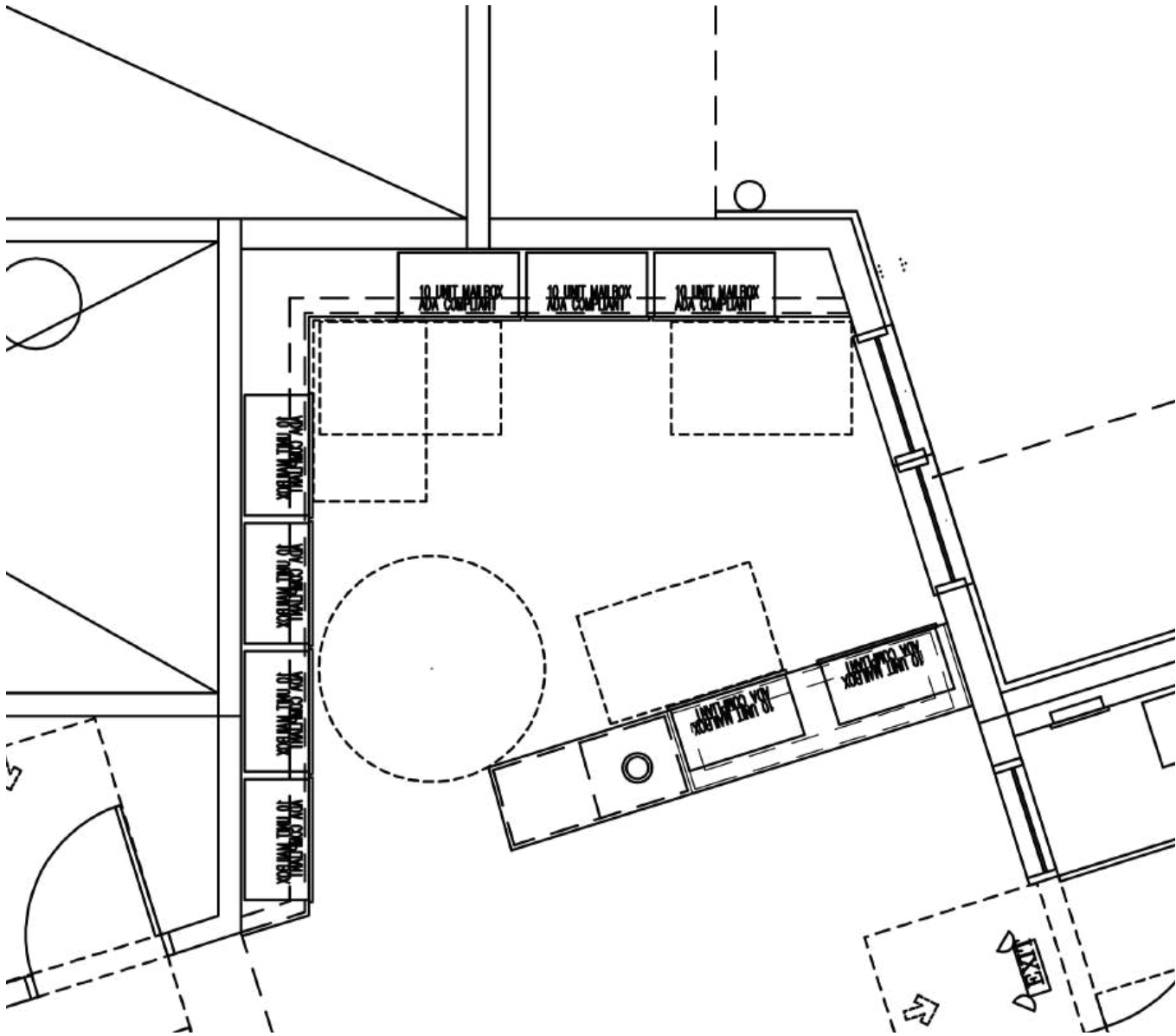

MAILROOM VIEW 1



RENTAL OFFICE

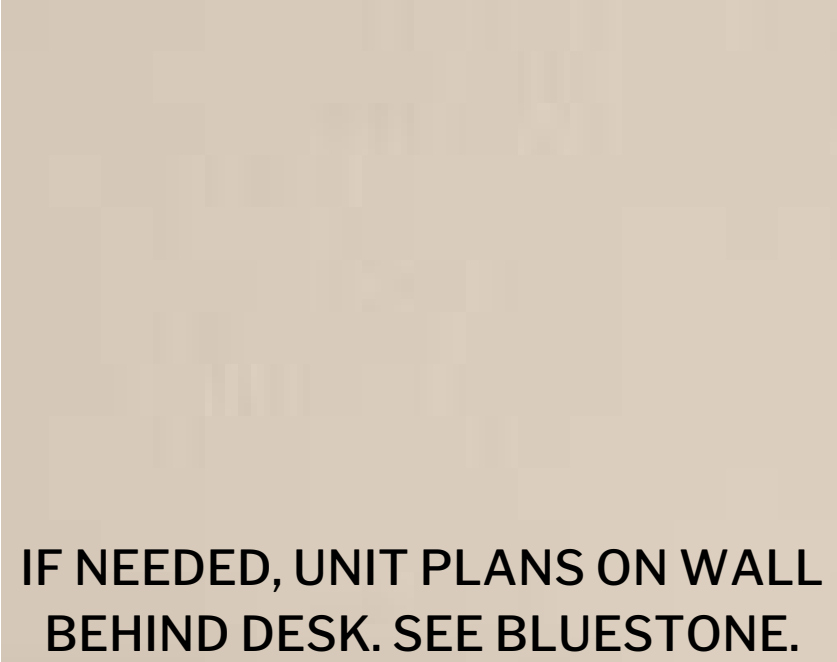
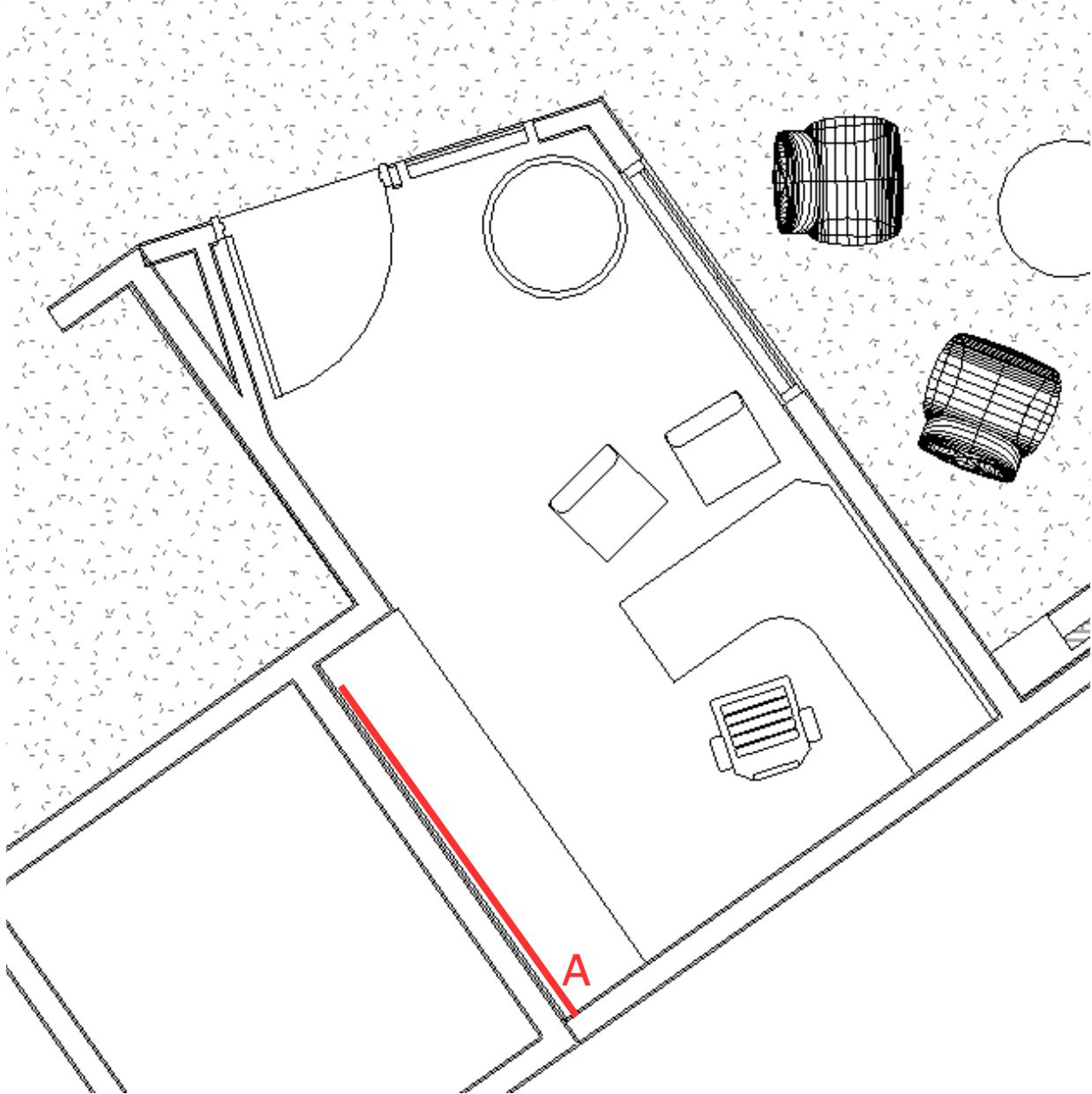

RENTAL OFFICE CASEWORK ELEVATION

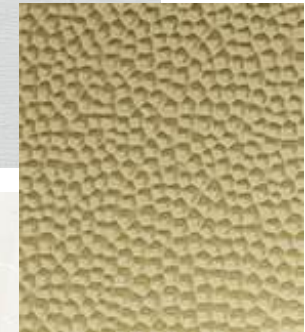
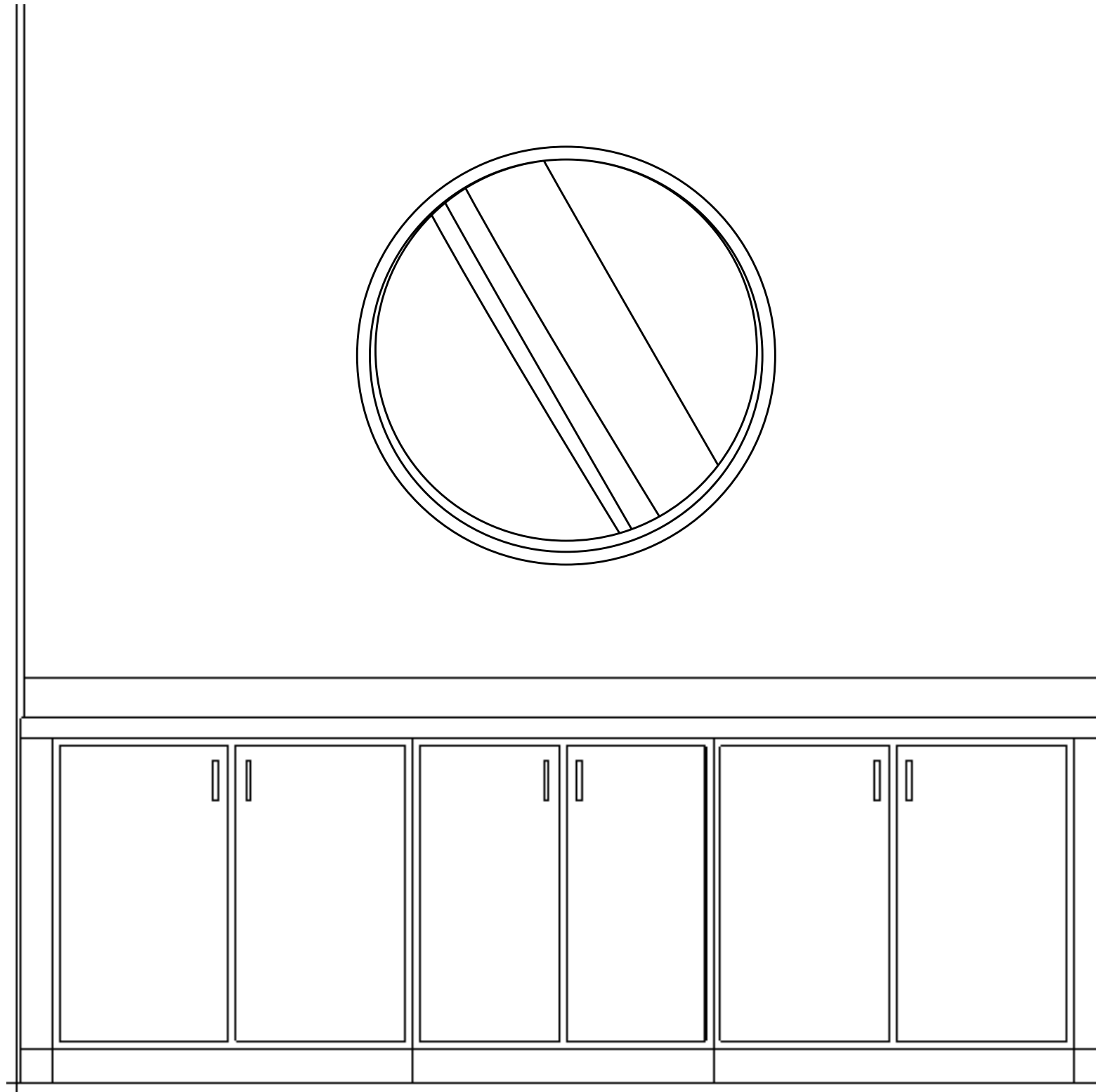

MASSAGE ROOM

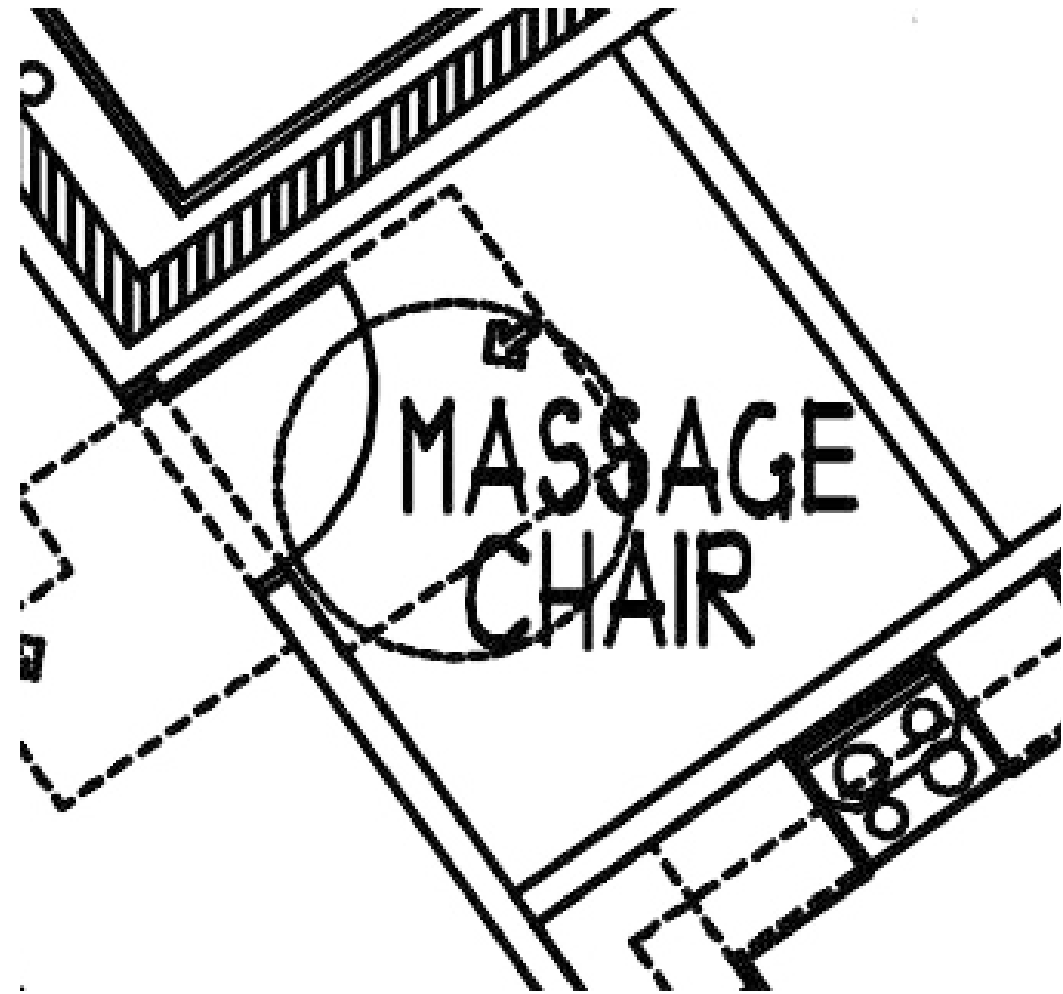

COMMUNITY ROOM

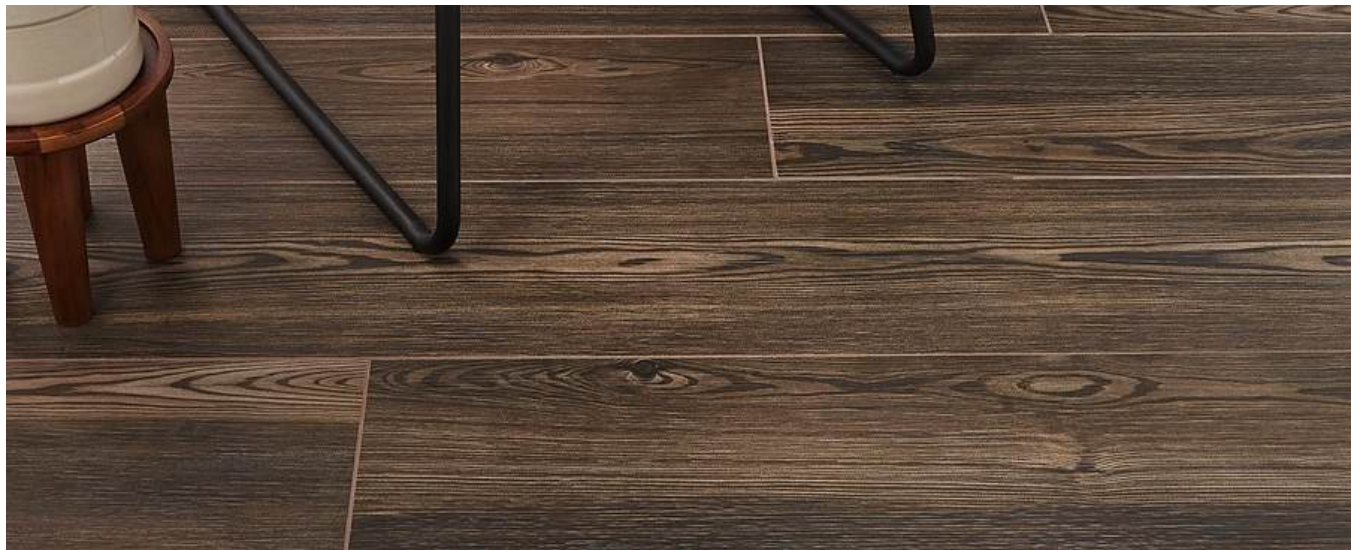
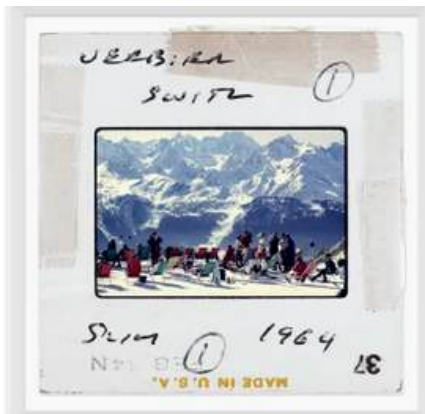

COMMUNITY ROOM RENDERING



COMMUNITY ROOM FURNITURE



COMMUNITY ROOM FURNITURE



COMMUNITY ROOM FURNITURE PLAN

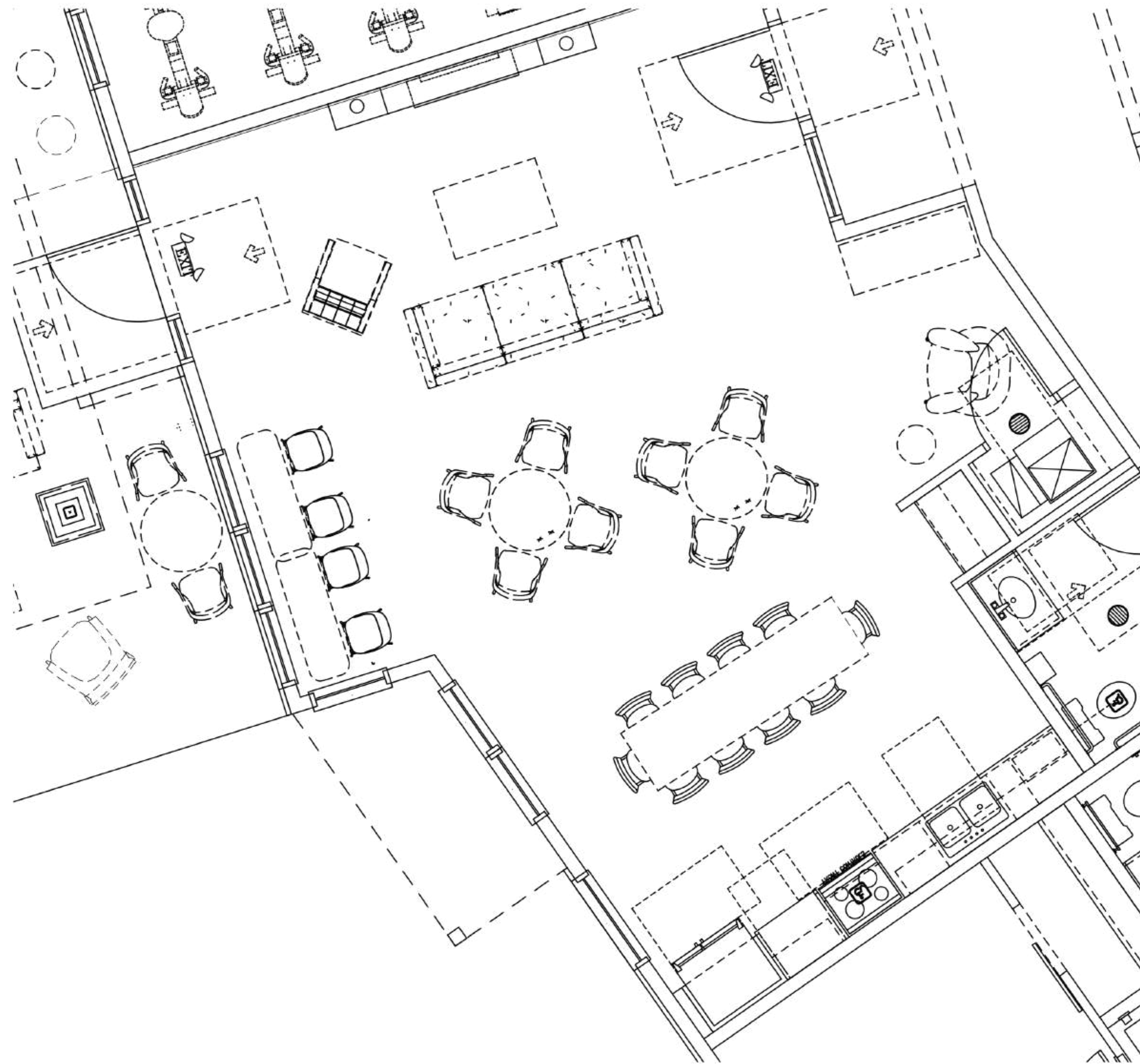

EXTERIOR FURNITURE



EXTERIOR FURNITURE PLAN

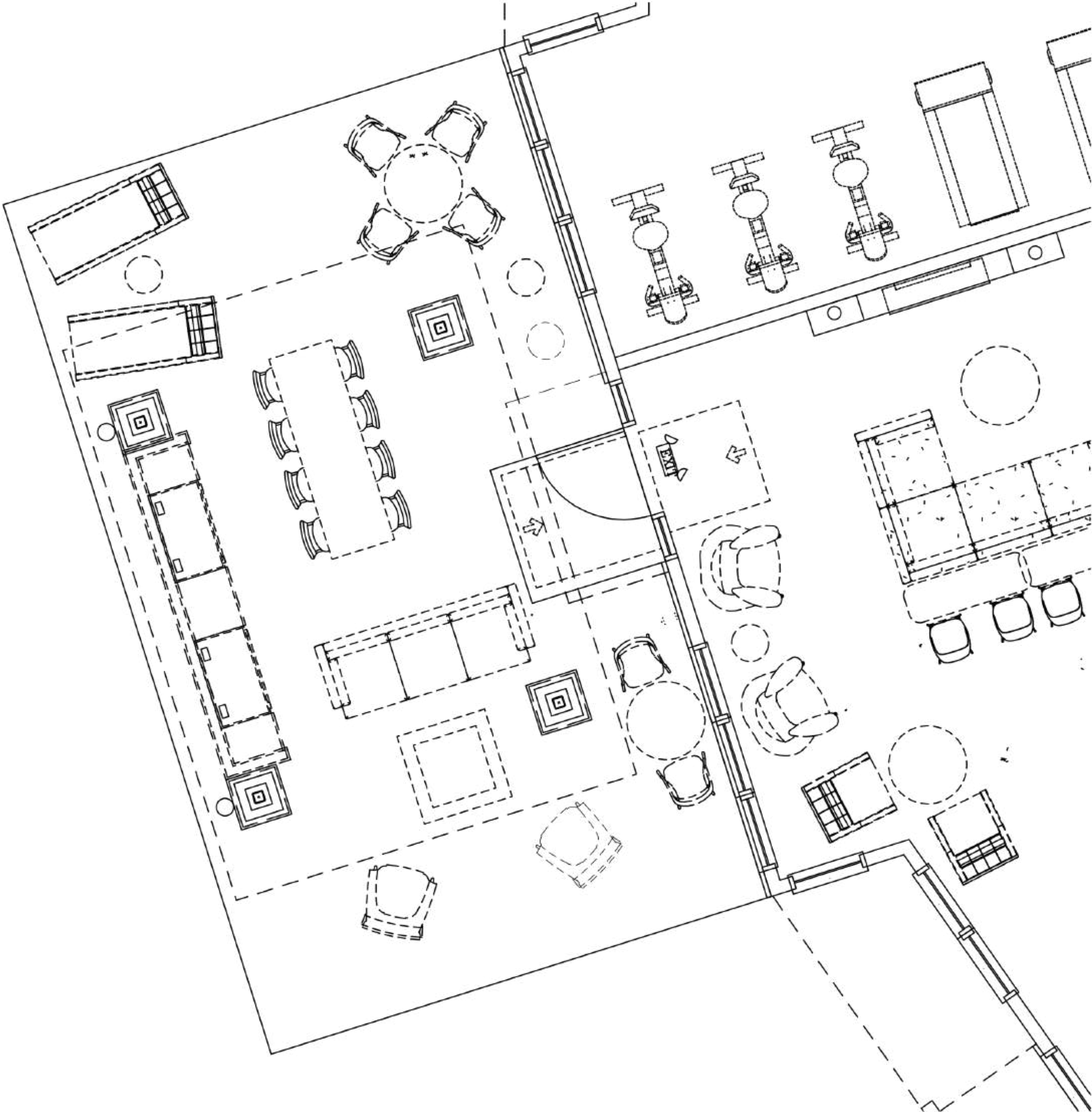

FAMILY RESTROOM

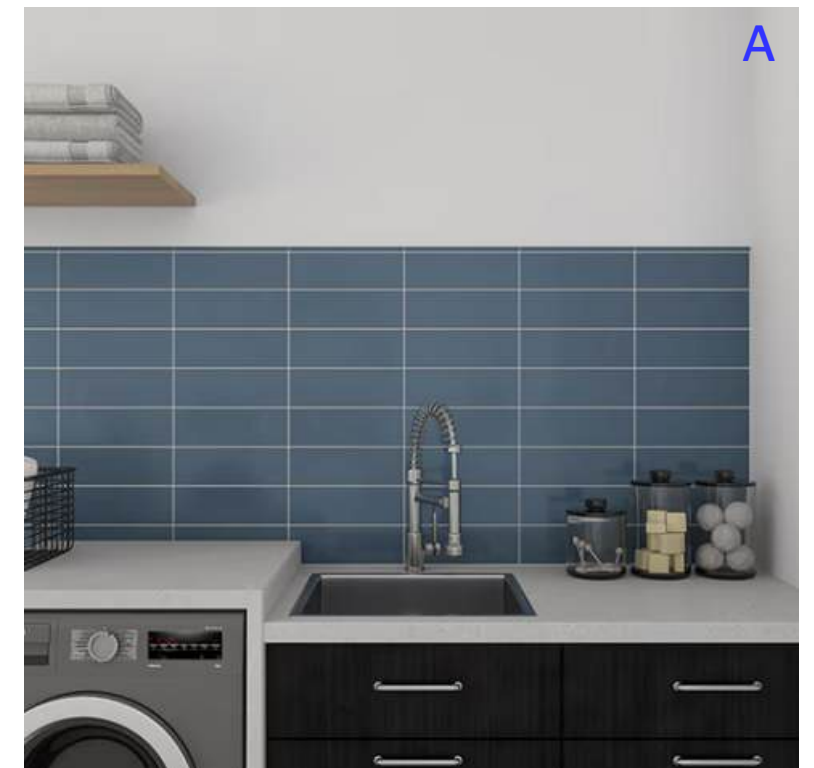
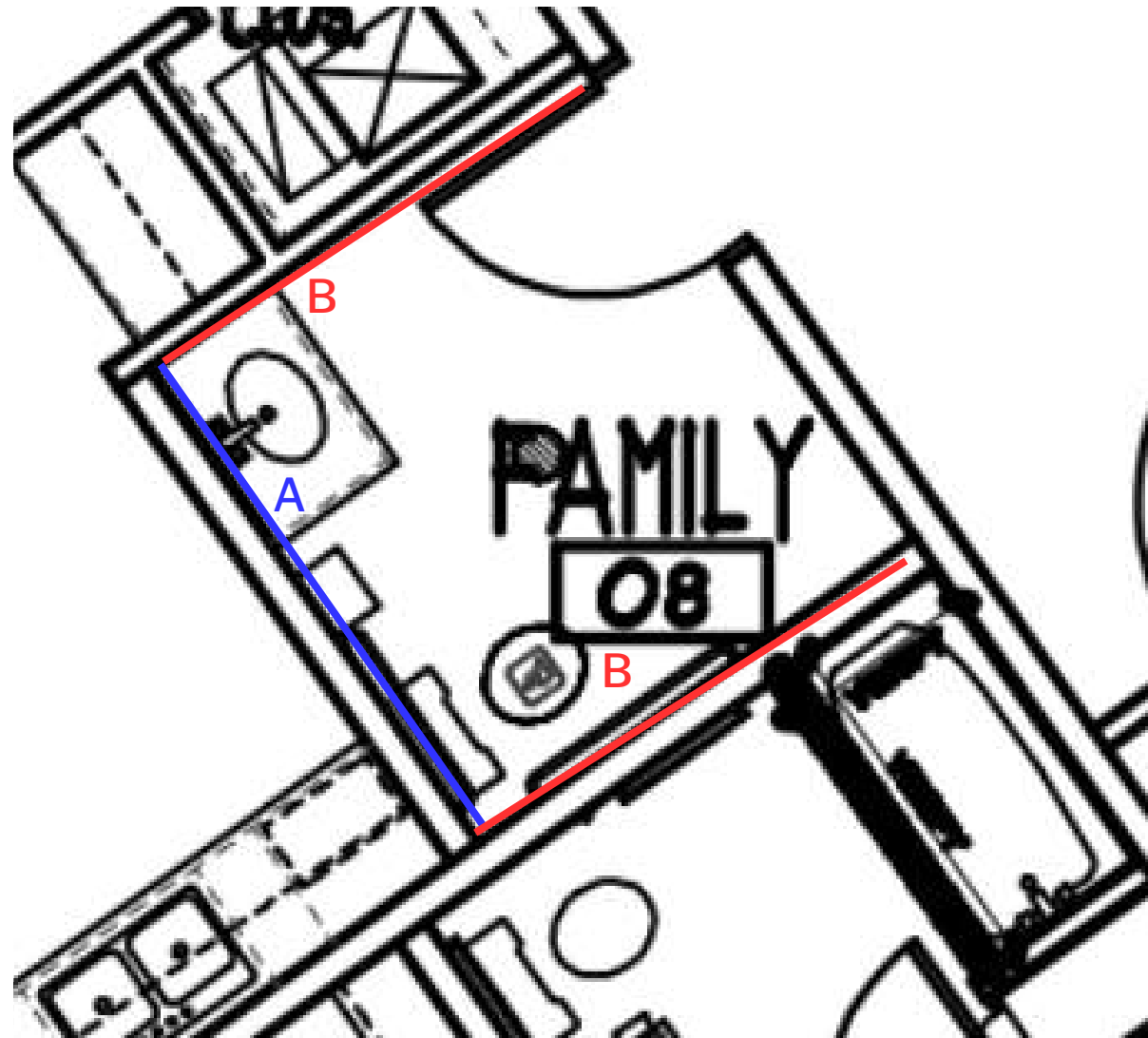

FITNESS ROOM

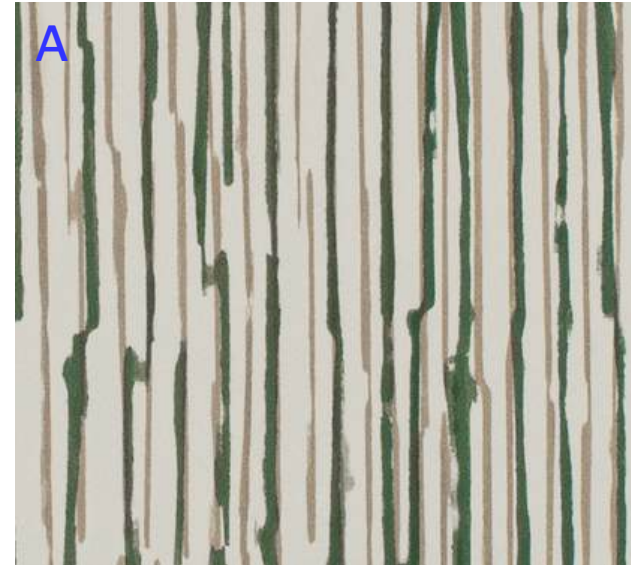
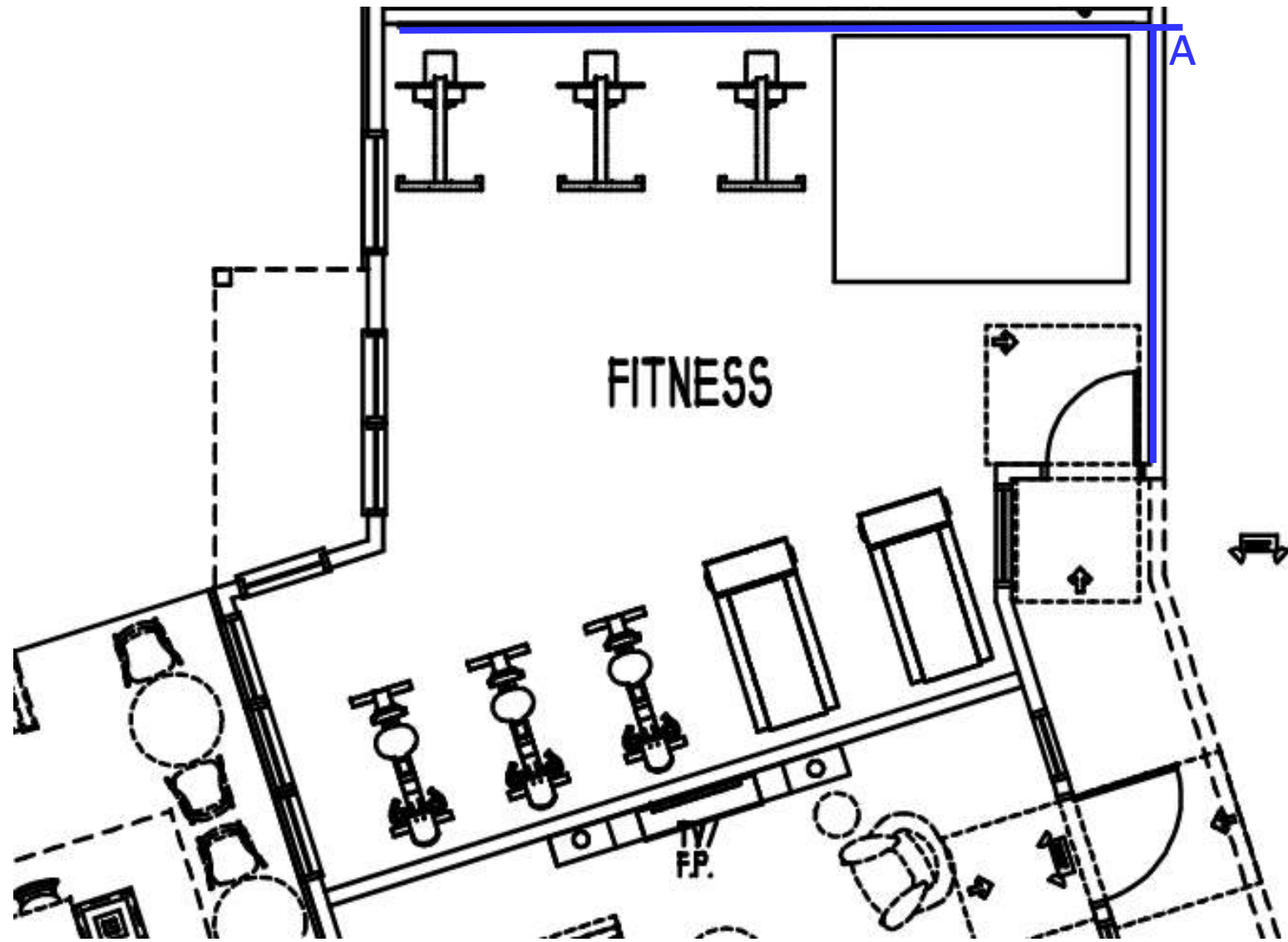

**FROSTED GLASS
WINDOWS -
INTERIOR AND
EXTERIOR**

PAW SPA

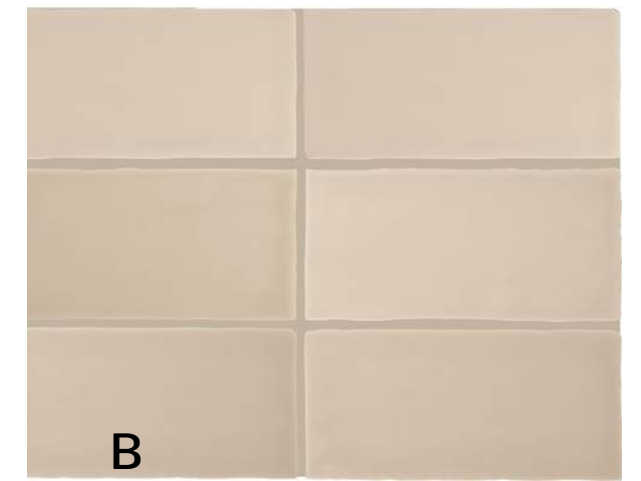
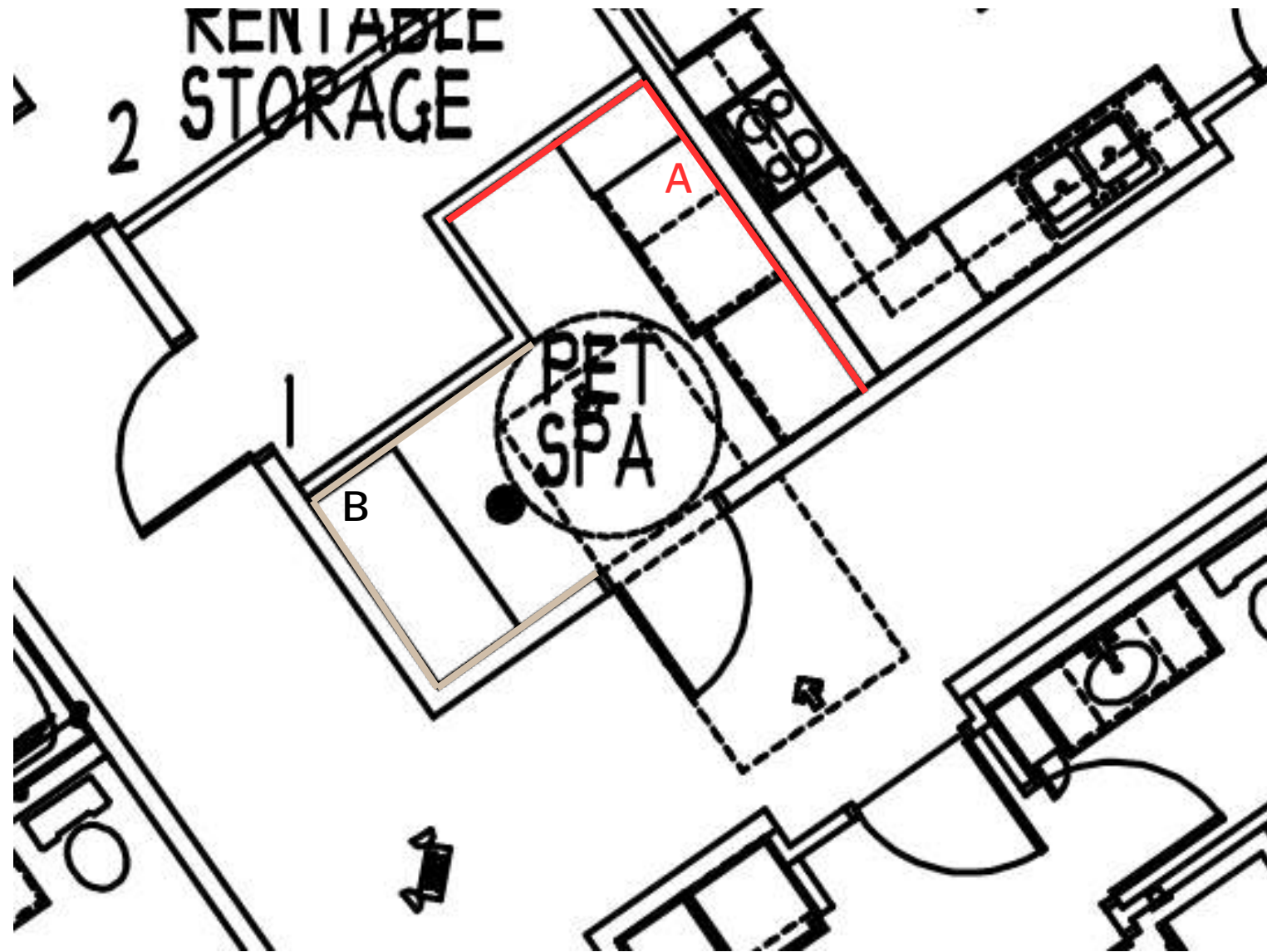

FIRST FLOOR CONFERENCE ROOM



FIRST FLOOR WORK SPACE

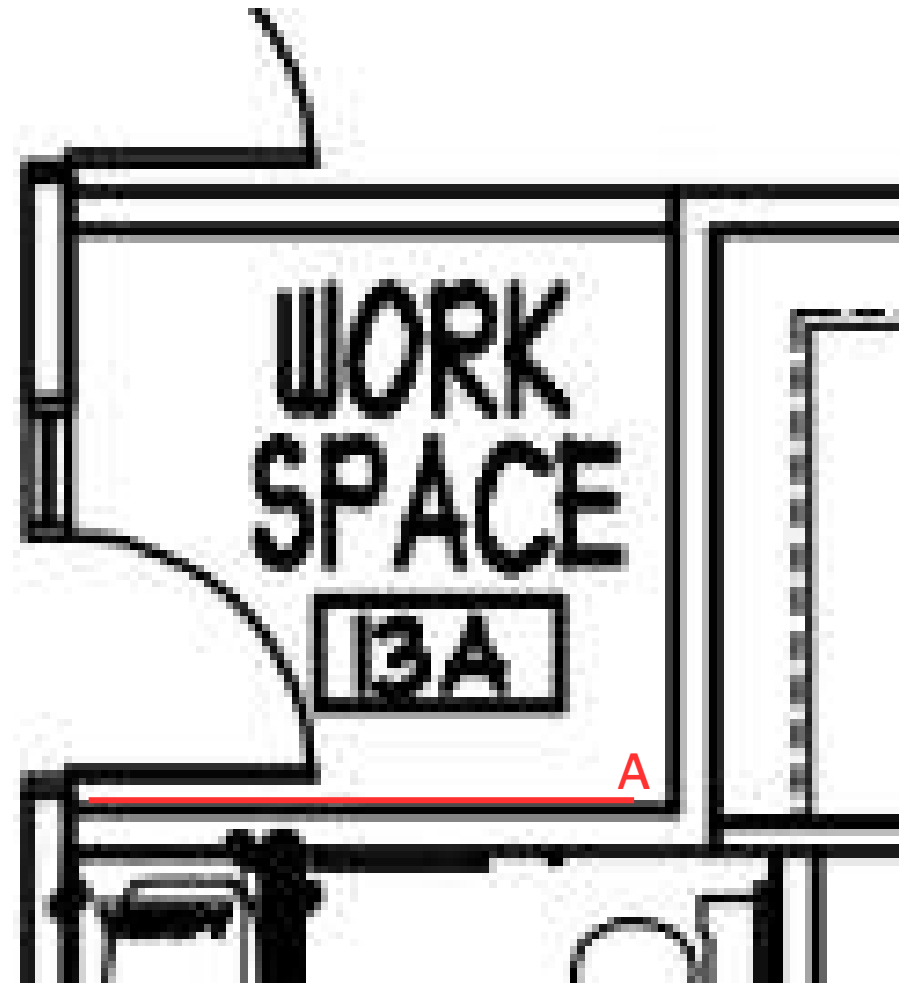

FIRST FLOOR ELEVATOR LOBBY

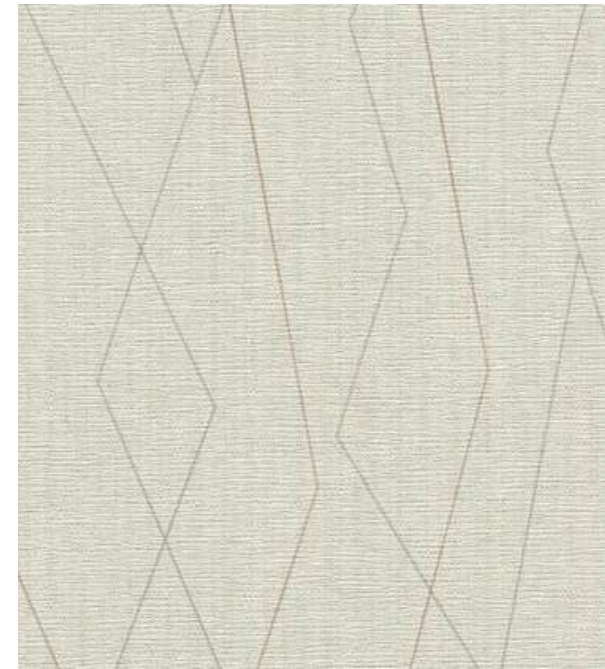

SECOND FLOOR ELEVATOR LOBBY

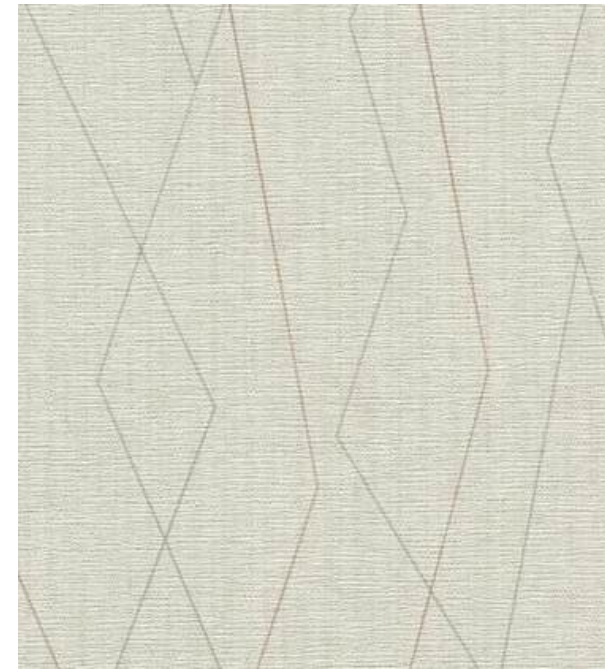

THIRD FLOOR ELEVATOR LOBBY

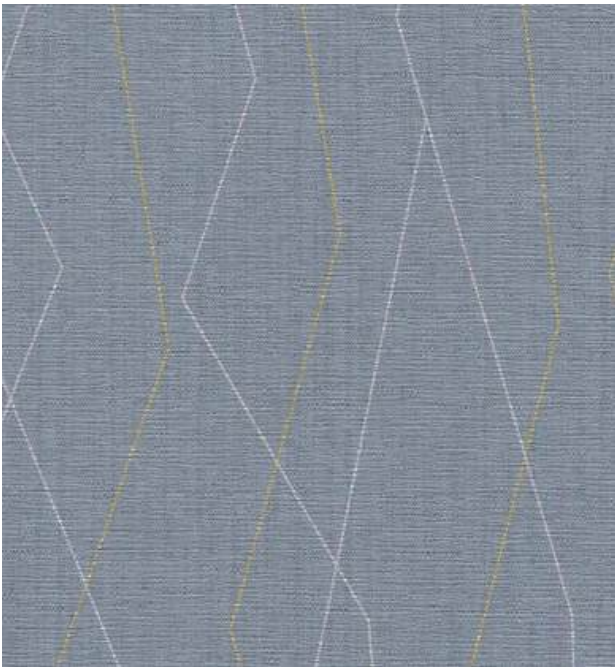

ELEVATOR LOBBY FURNITURE PLAN 1

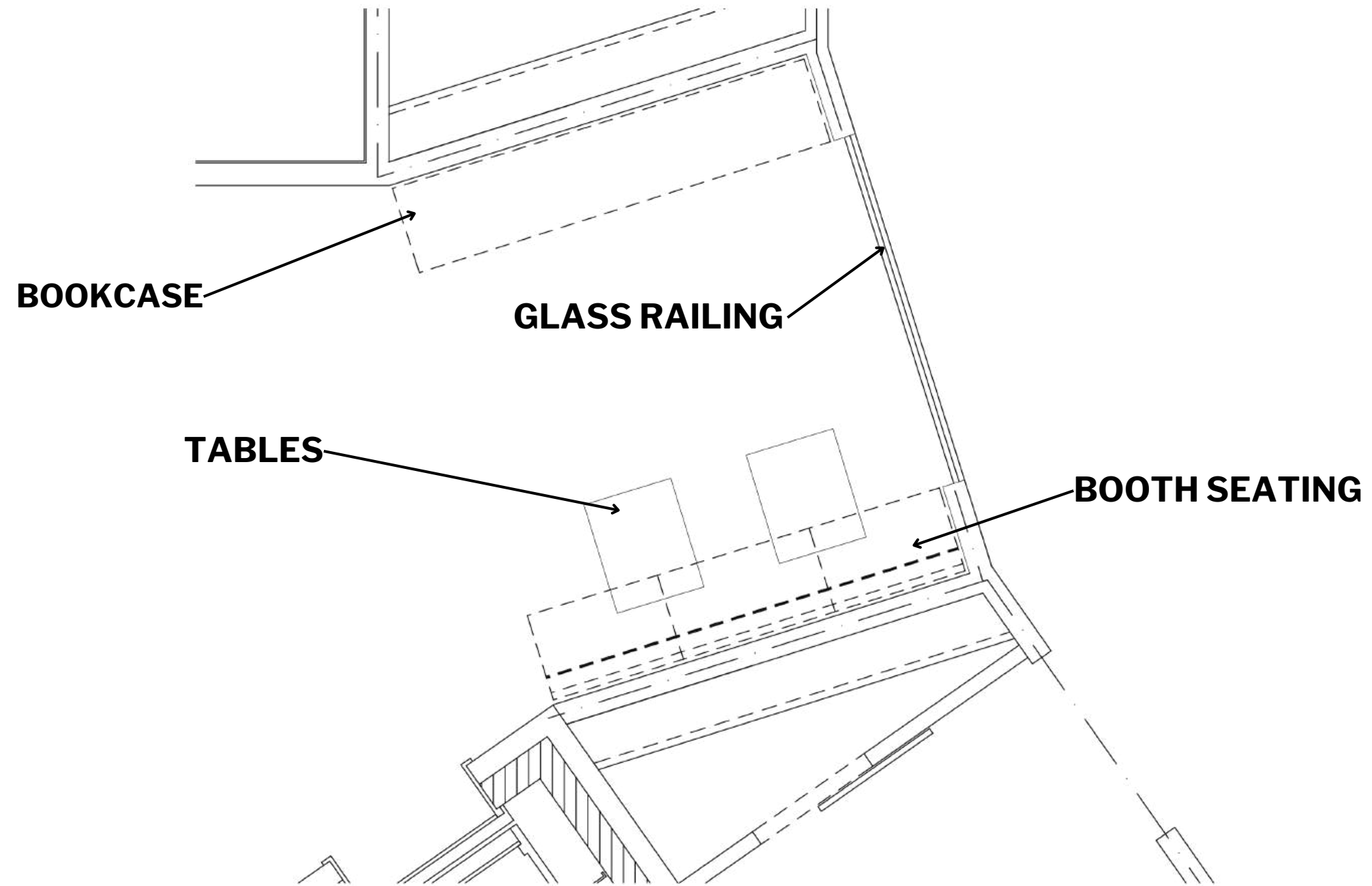

ELEVATOR LOBBY FURNITURE PLAN 2

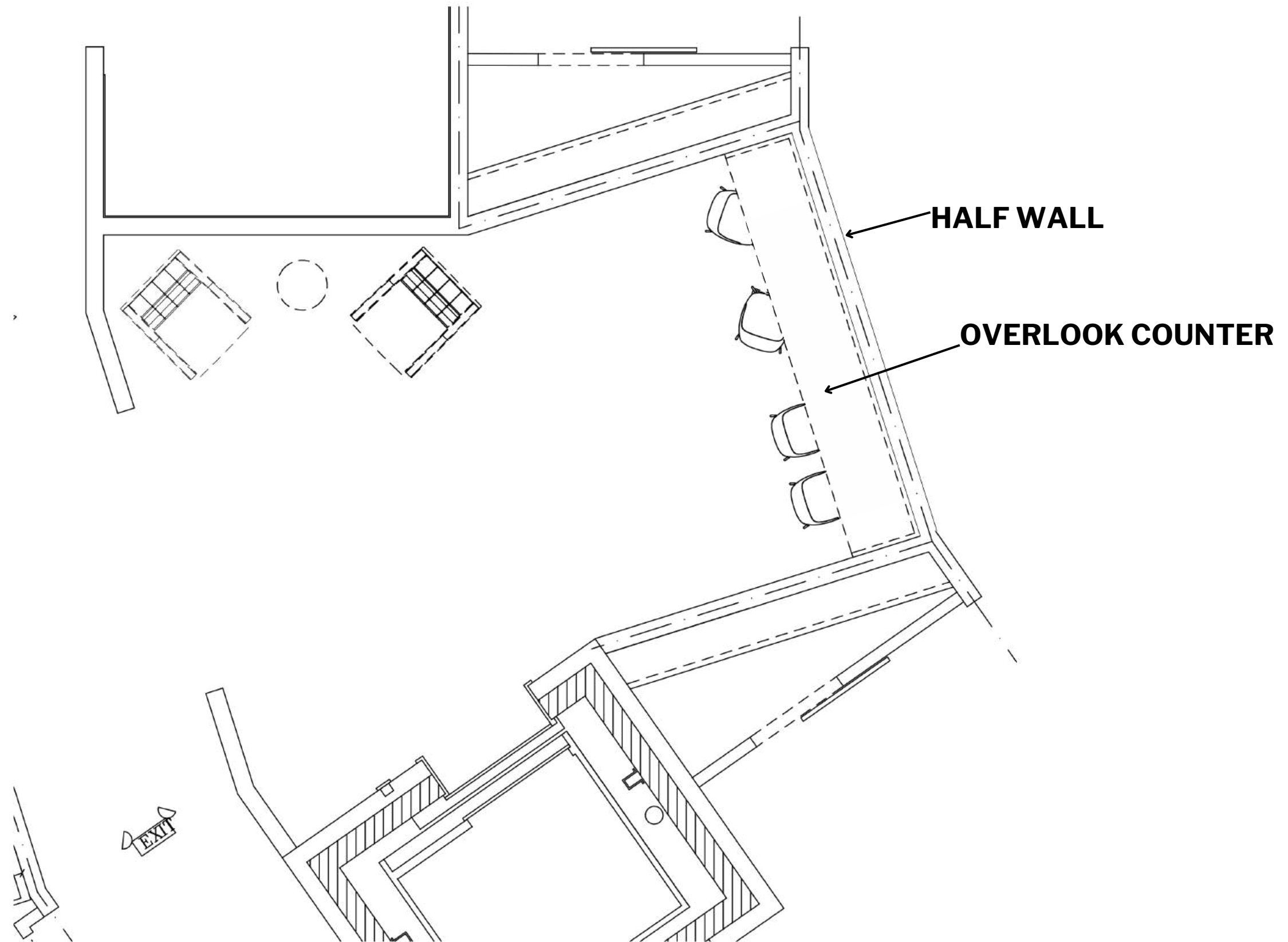

ELEVATOR LOBBY FURNITURE PLAN 3

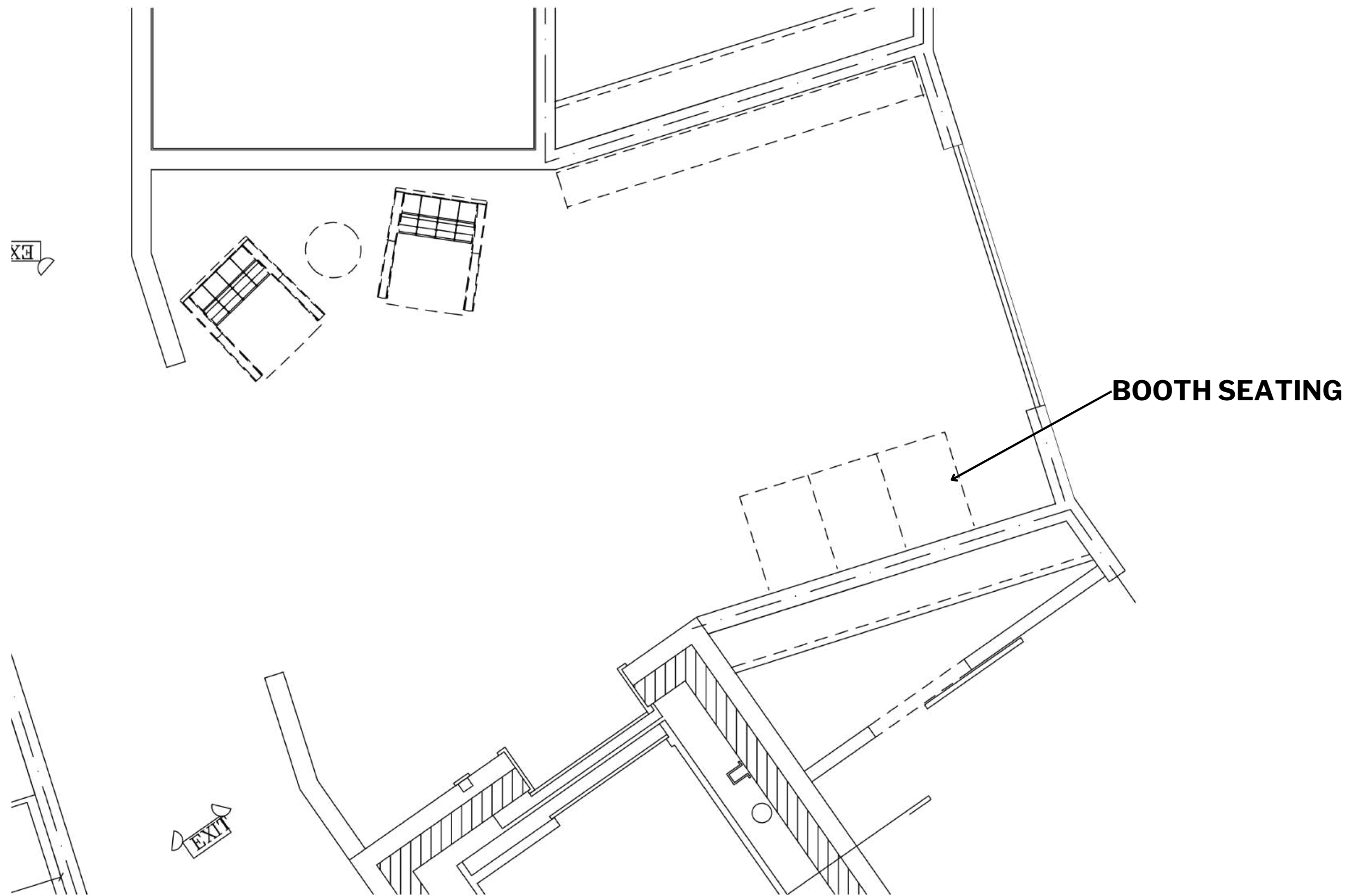

HALLWAY CARPET LAYOUTS



INSTALLATION RENDERING

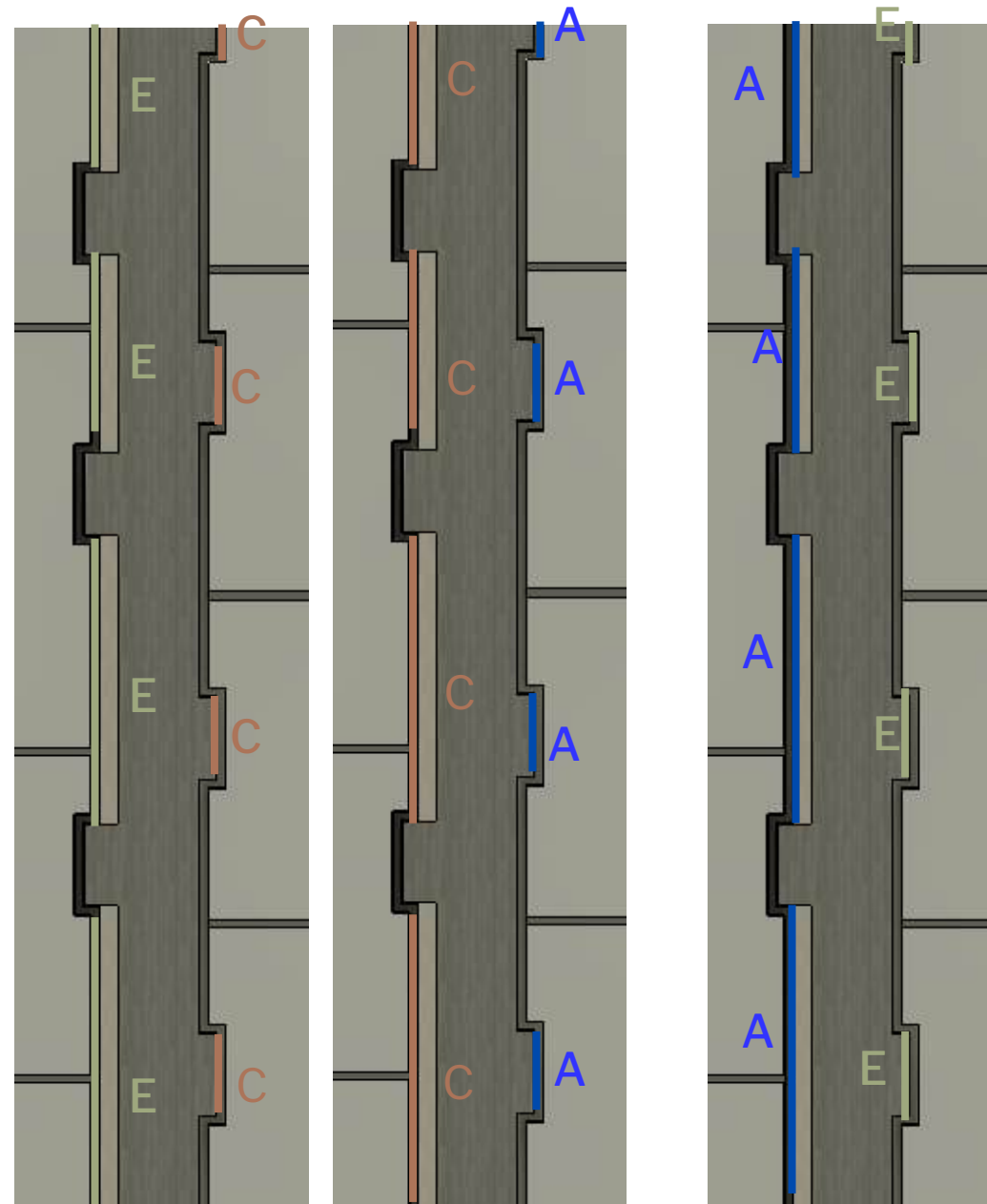

FIRST FLOOR

SECOND FLOOR

THIRD FLOOR

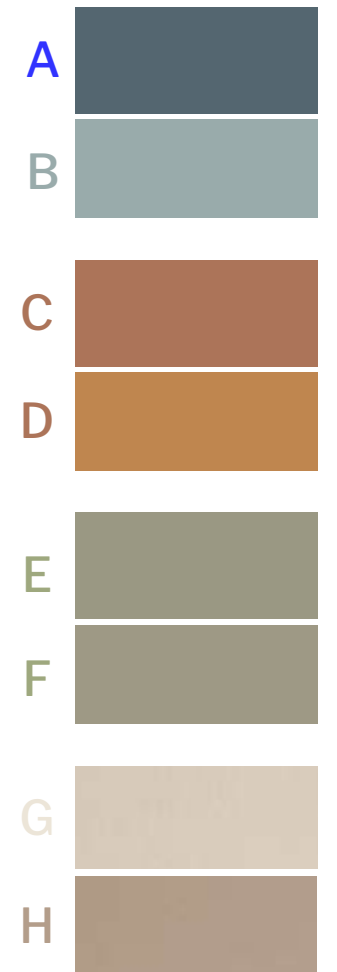

A

B

C

D

E

F

G

H

HALLWAY ART



UNIT OPTION 1

OPTIONS

WHITE WALL CABINETS

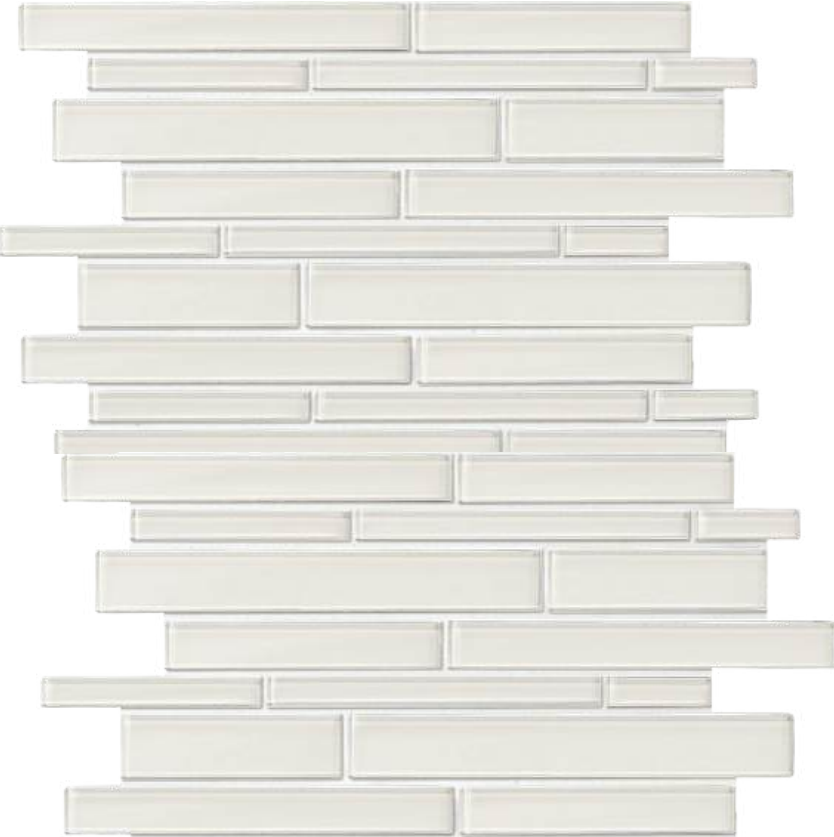

HUSK BASE CABINETS

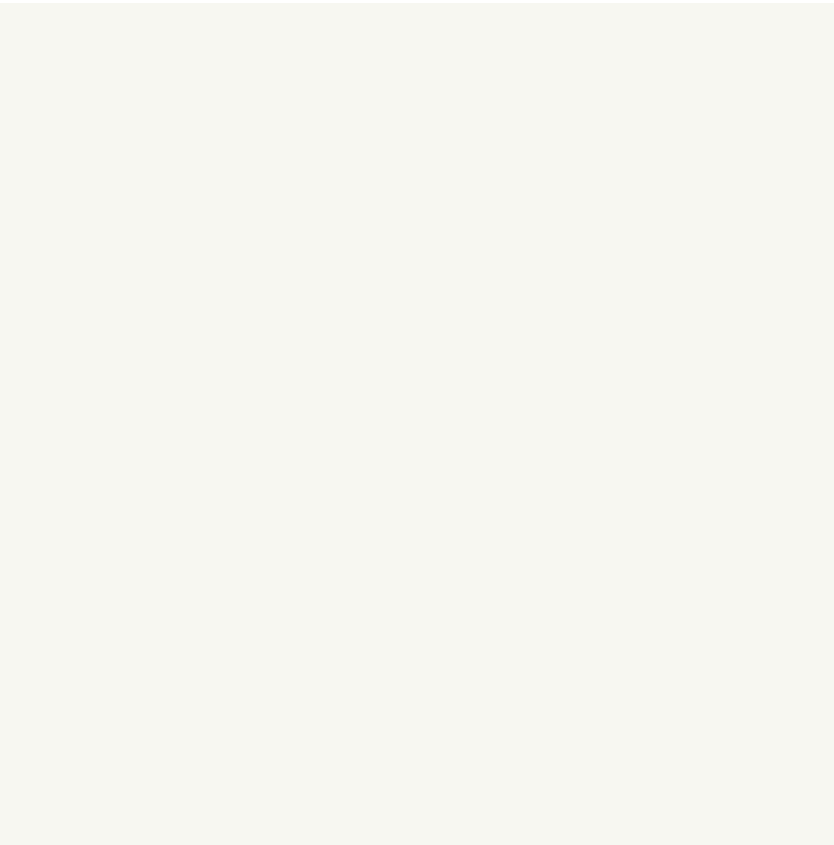

UNIT OPTION 2

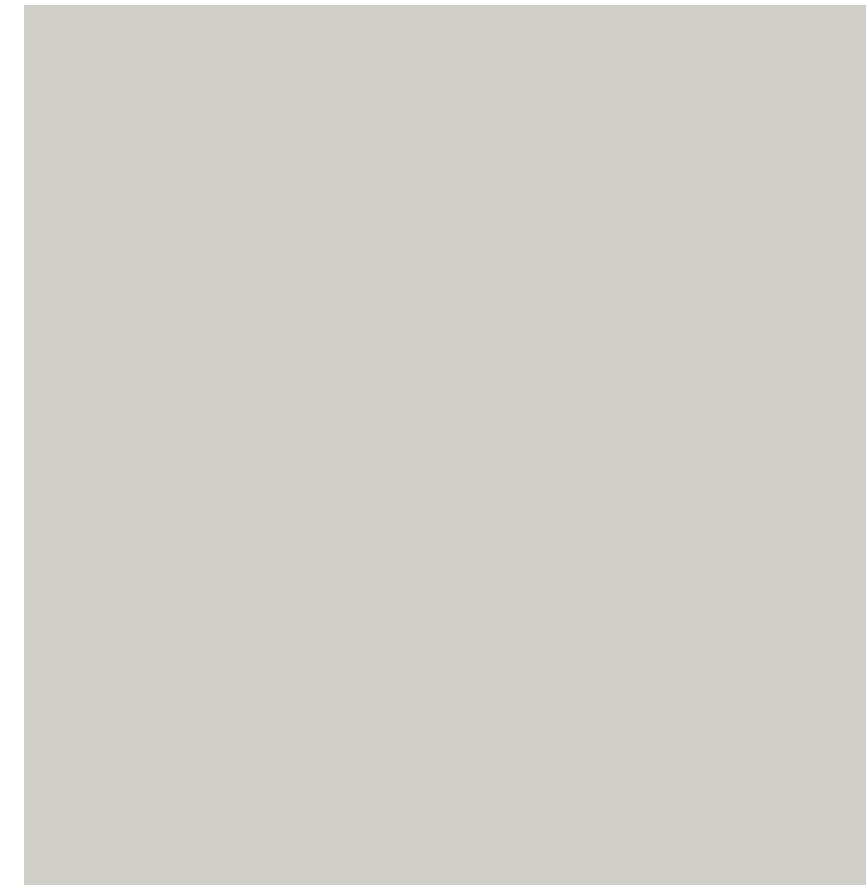
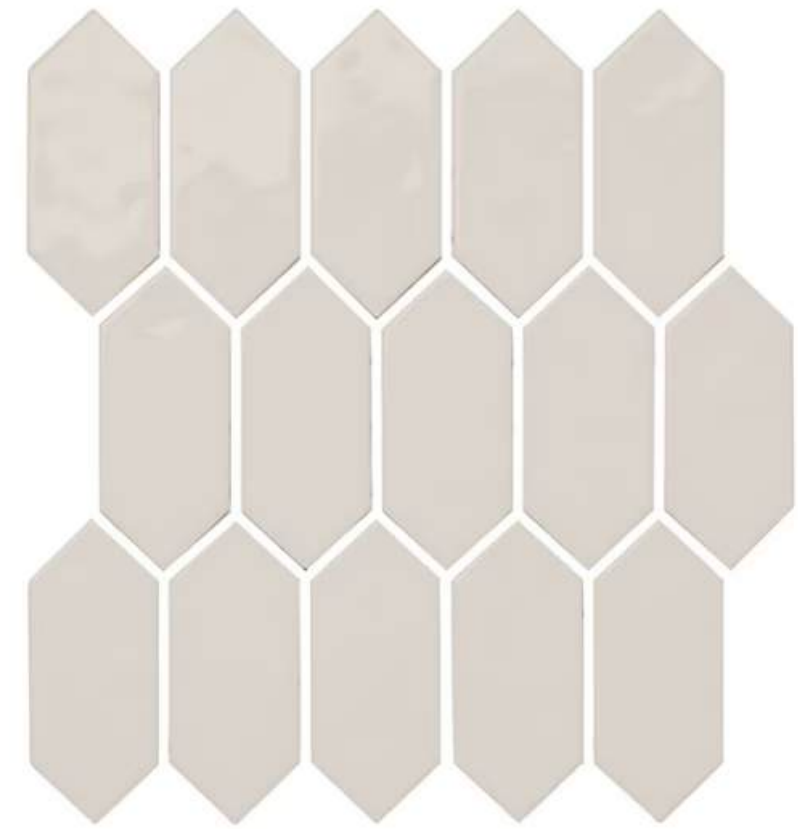

LIGHTING

LOBBY CHANDELIER

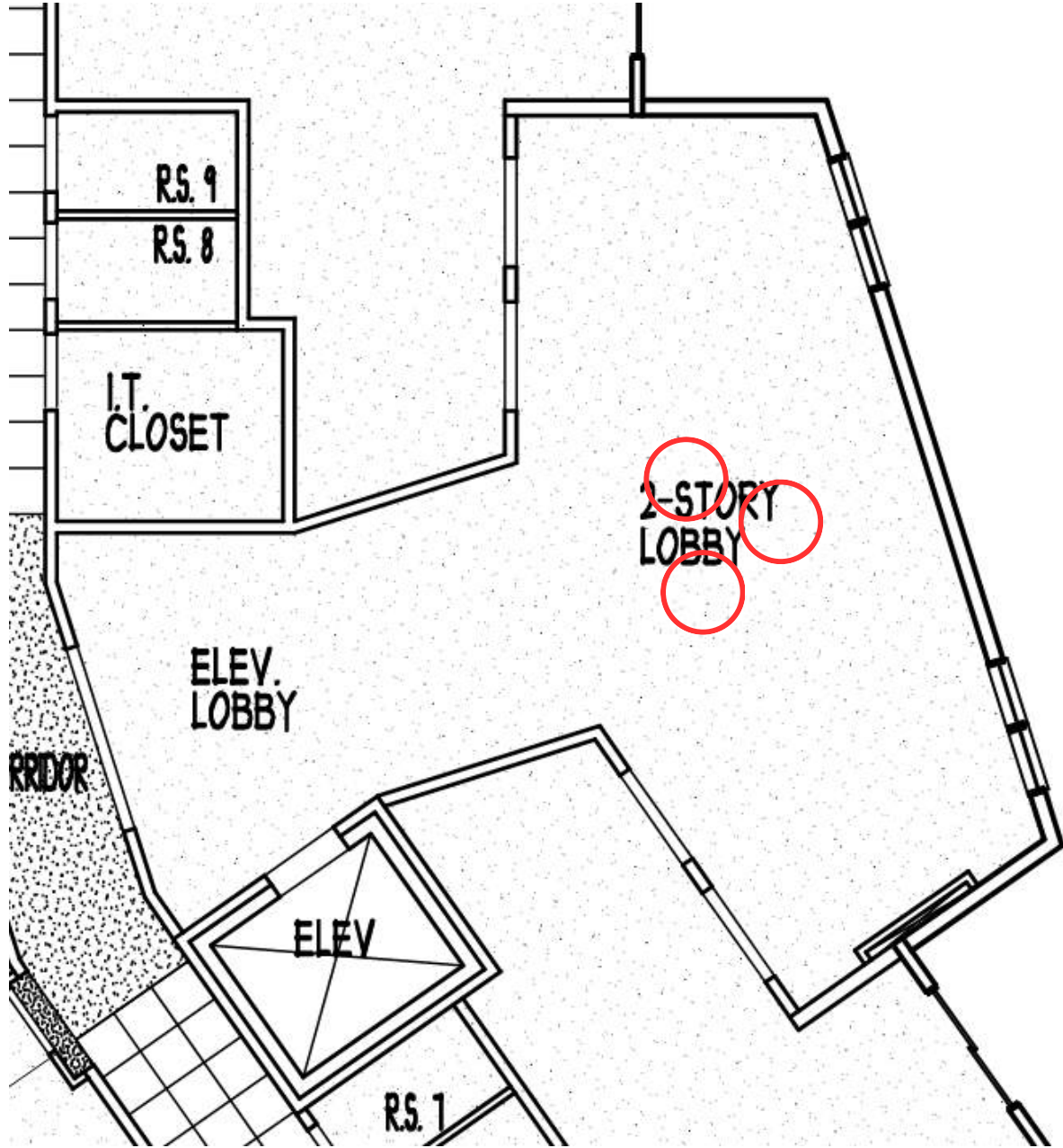

L1



FIREPLACE LOUNGE

L2



FIRST FLOOR ELEVATOR LOBBY

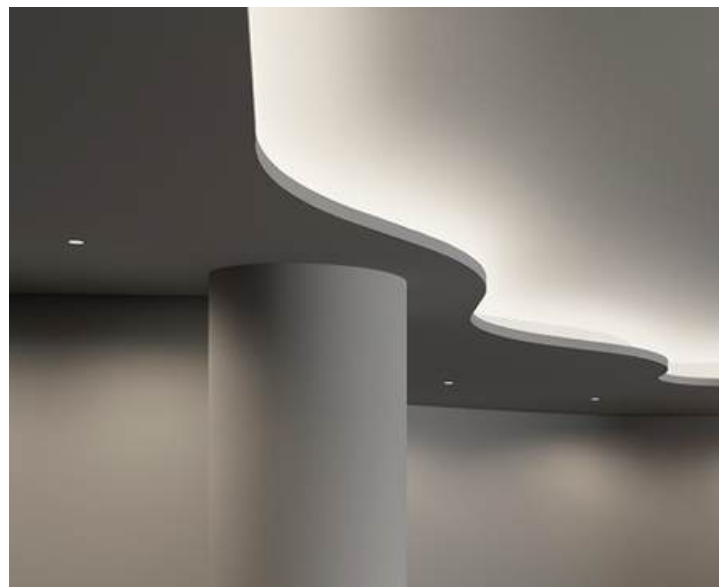
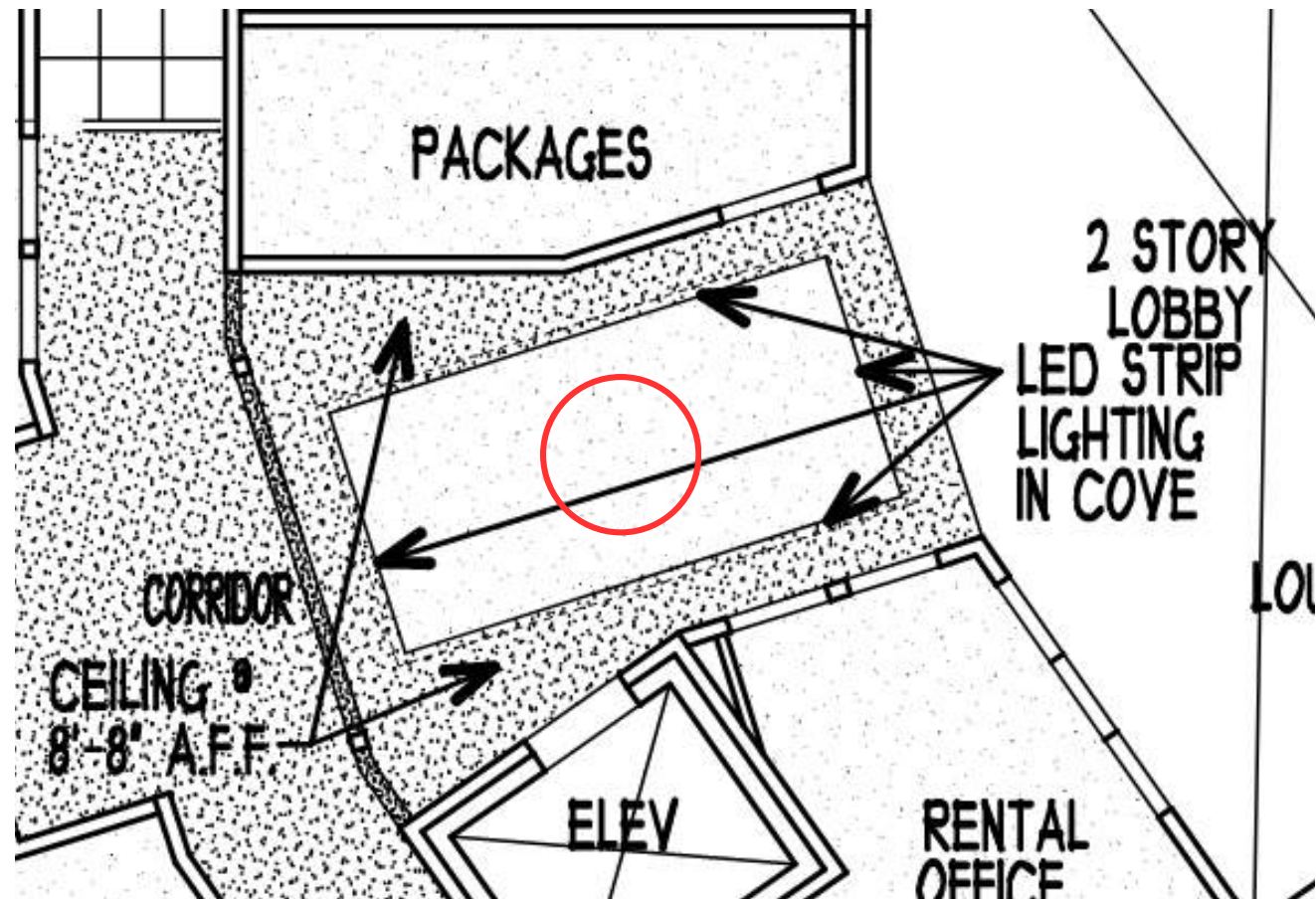

COVE LIGHTING - SIMILAR TO SAND LAKE

OVERALL RECESSED CAN



L4

COMMUNITY ROOM

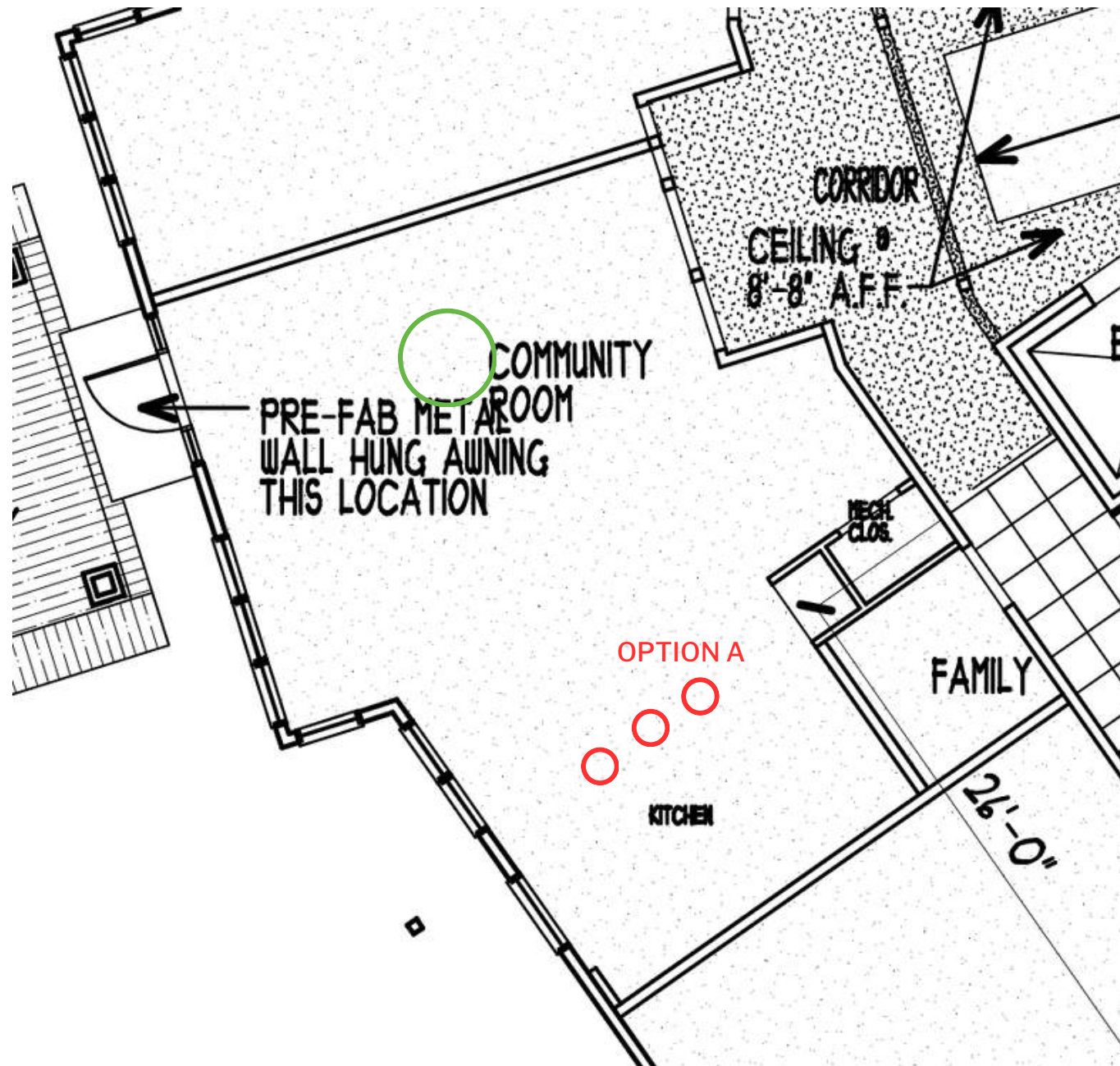

L6



OVER COFFEE TABLE/ SOFA

FITNESS

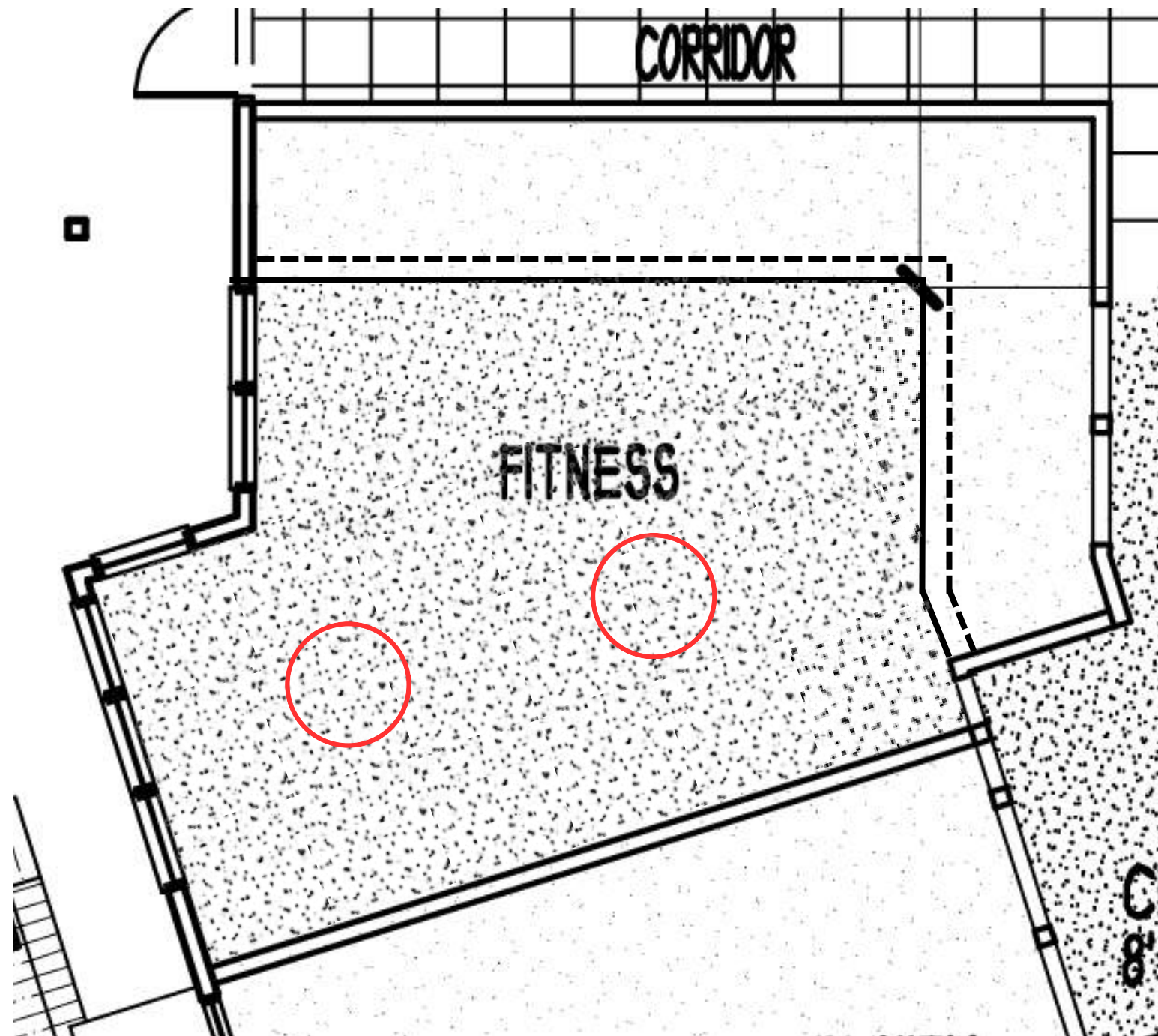

L7



COVE LIGHTING - SIMILAR TO SAND LAKE

L8



SUPPLIMENTAL SURFACE MOUNT

MASSAGE CHAIR ROOM

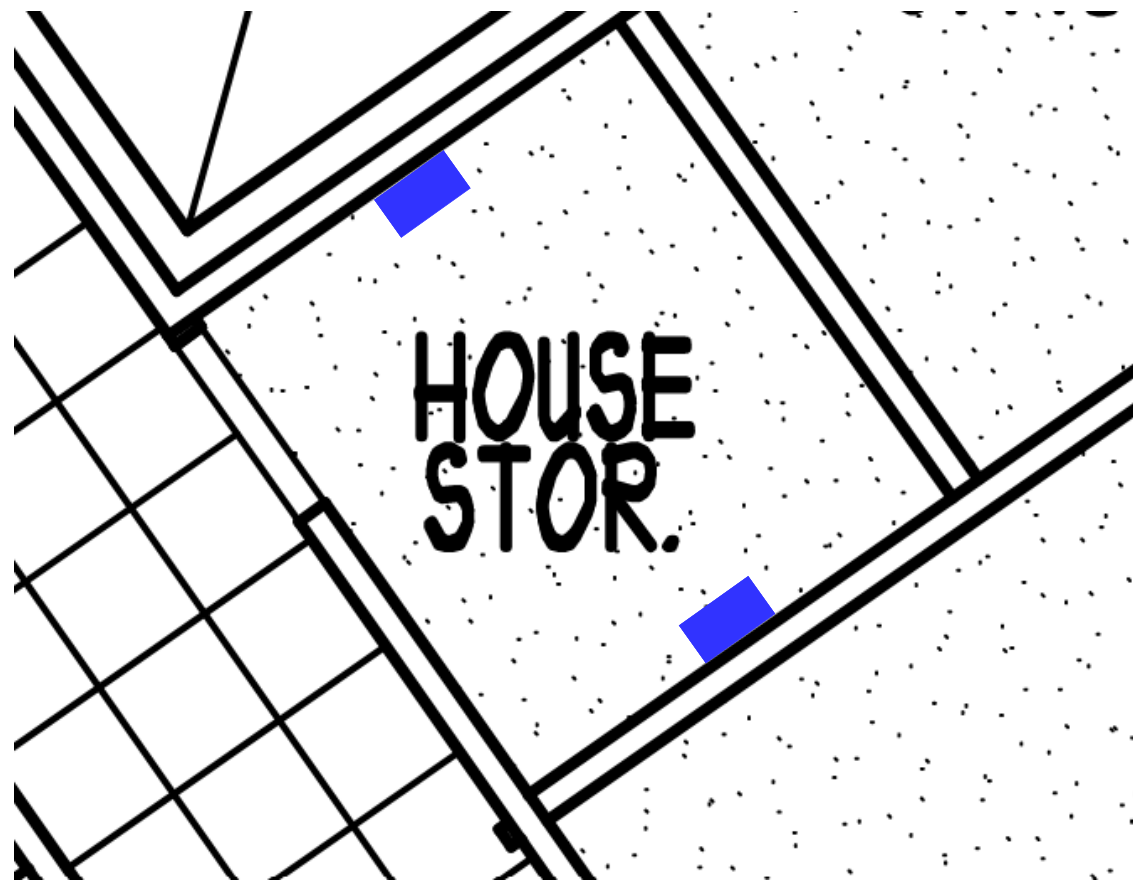

L9



UP AND DOWN LIGHTING, DIMMABLE

FIRST FLOOR CONFERENCE ROOM

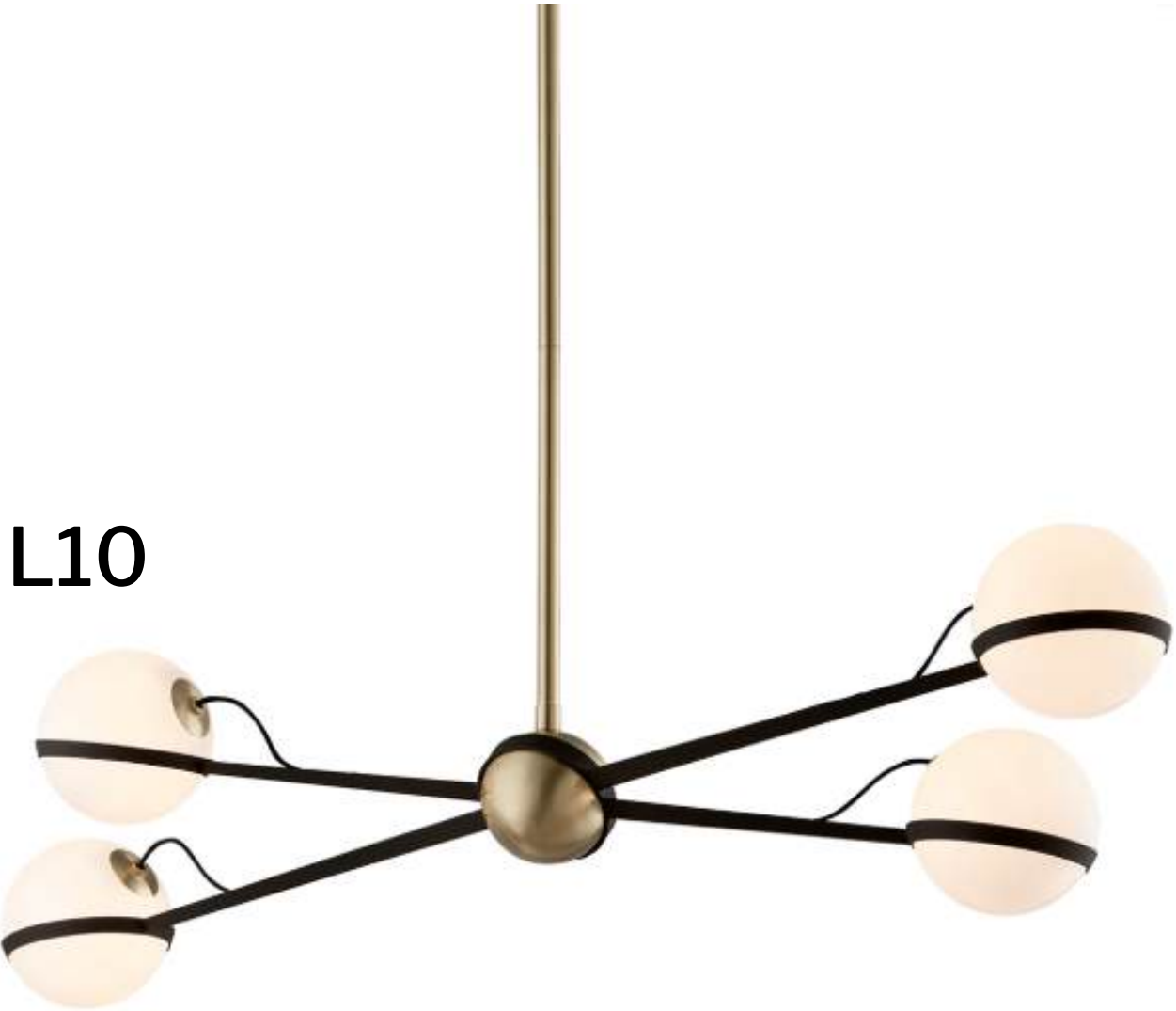
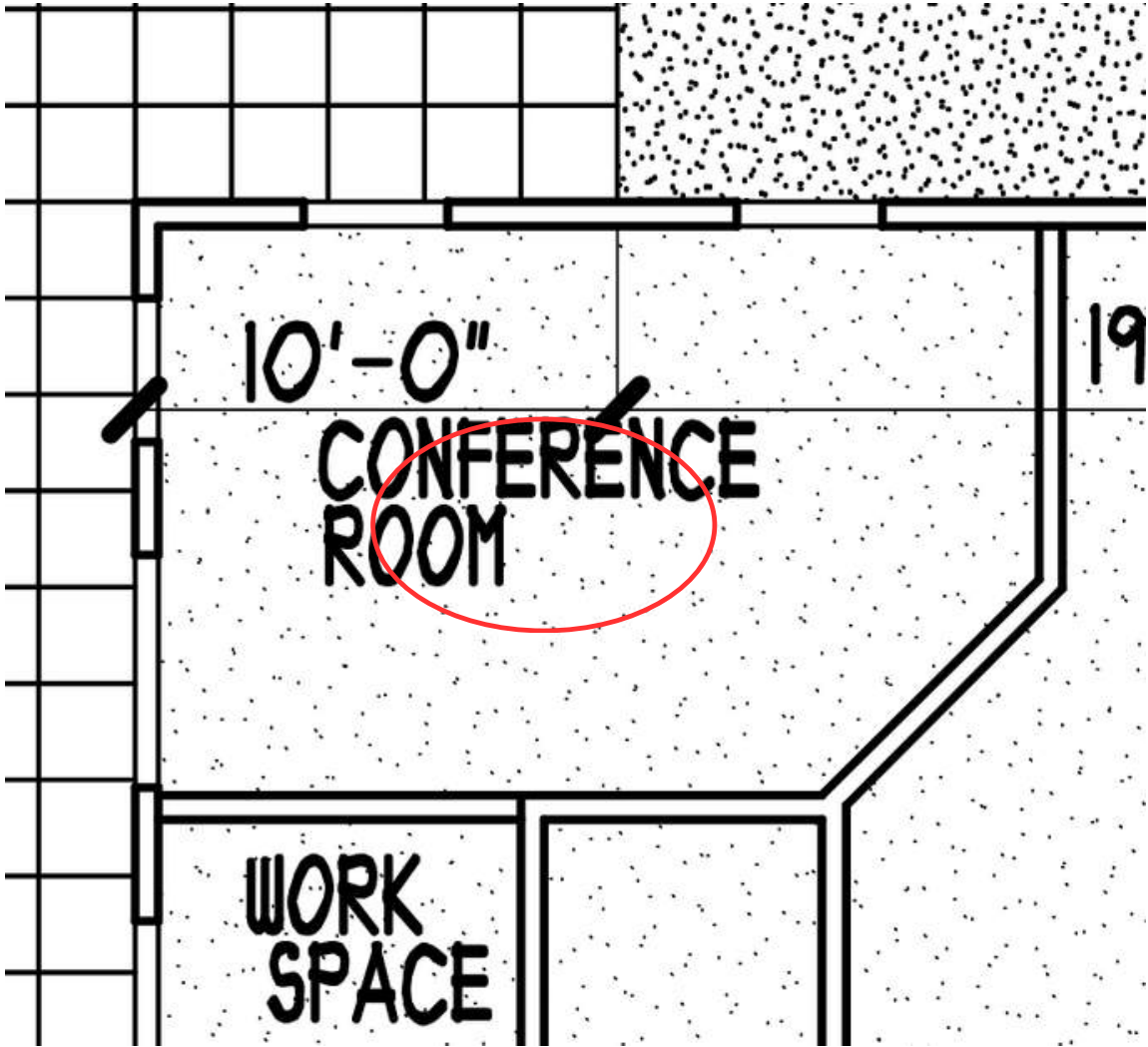

FIRST FLOOR WORK SPACE

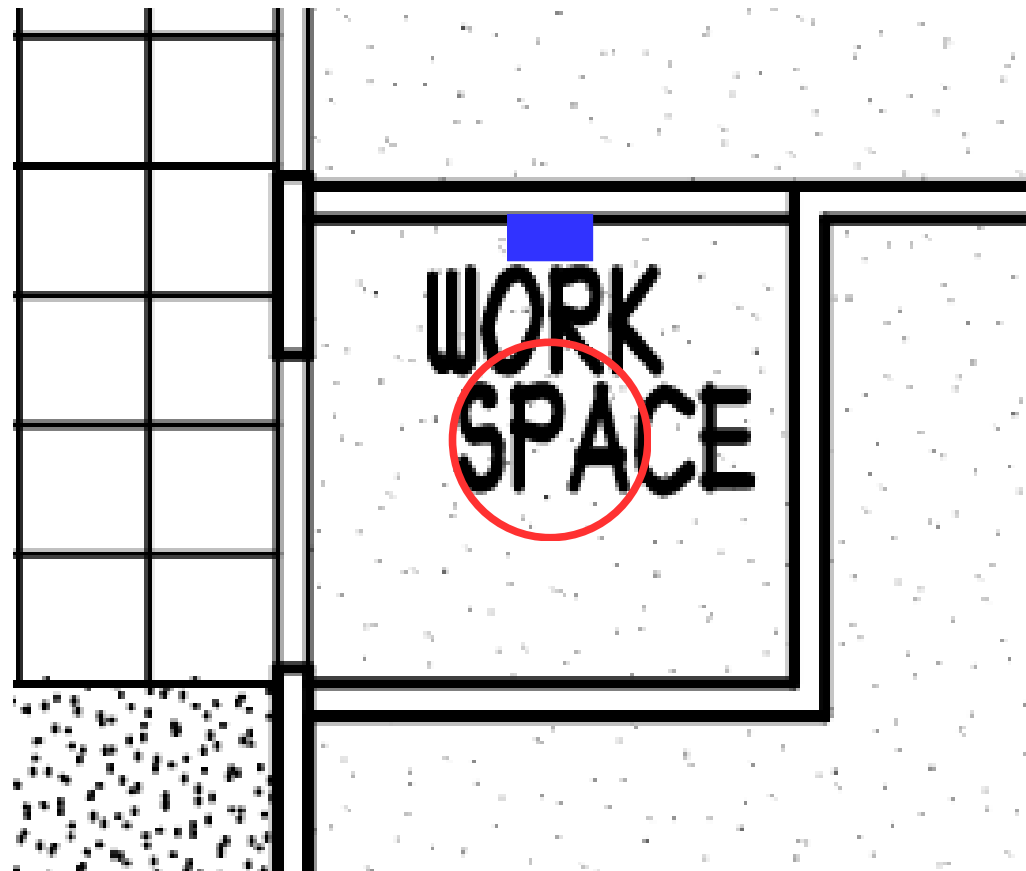

L6



CEILING

L11



SCONCE - FOR LIGHTING USER'S FACES
FOR ONLINE MEETINGS

SECOND FLOOR ELEVATOR LOBBY

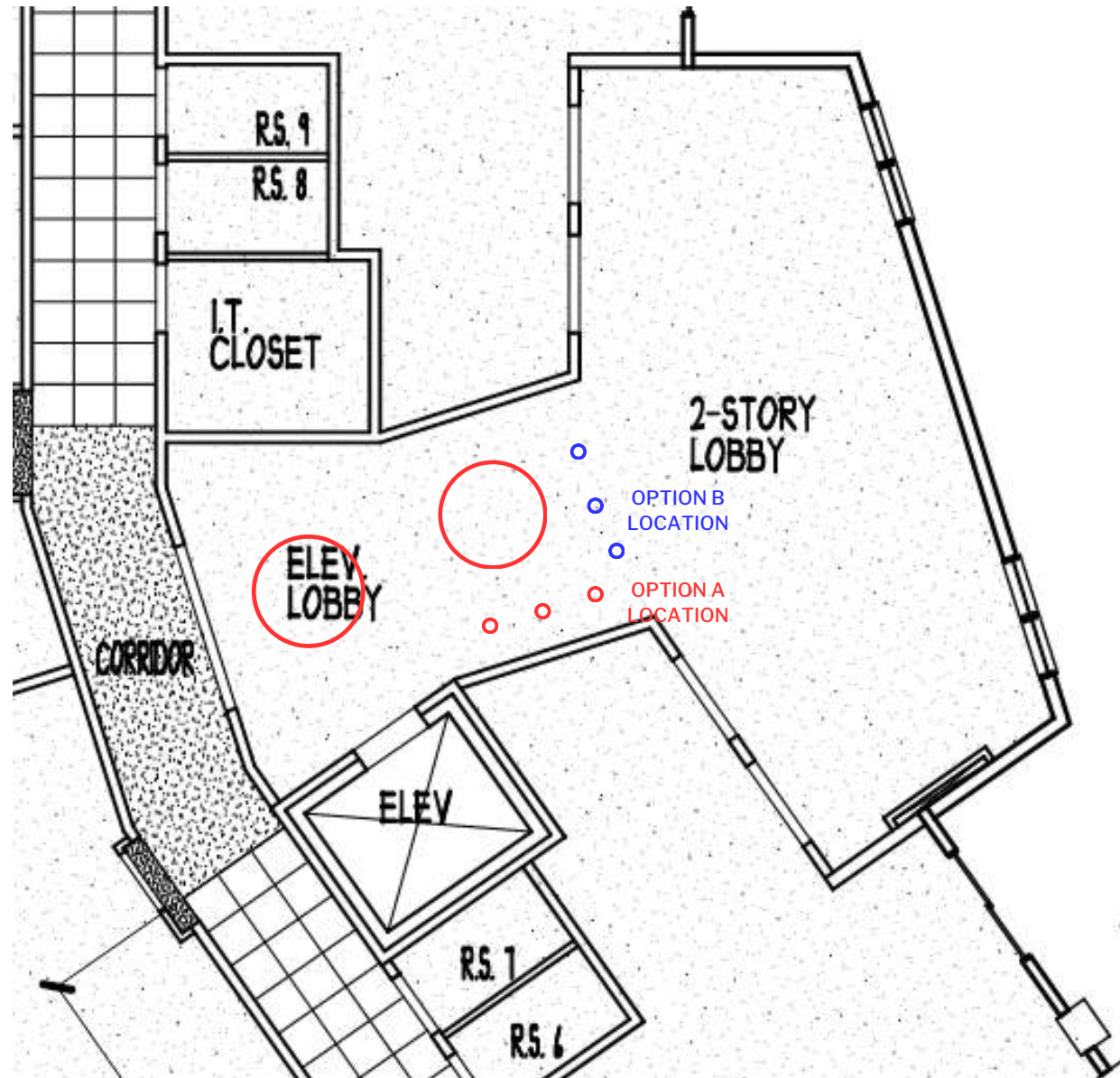

L3



THIRD FLOOR ELEVATOR LOBBY

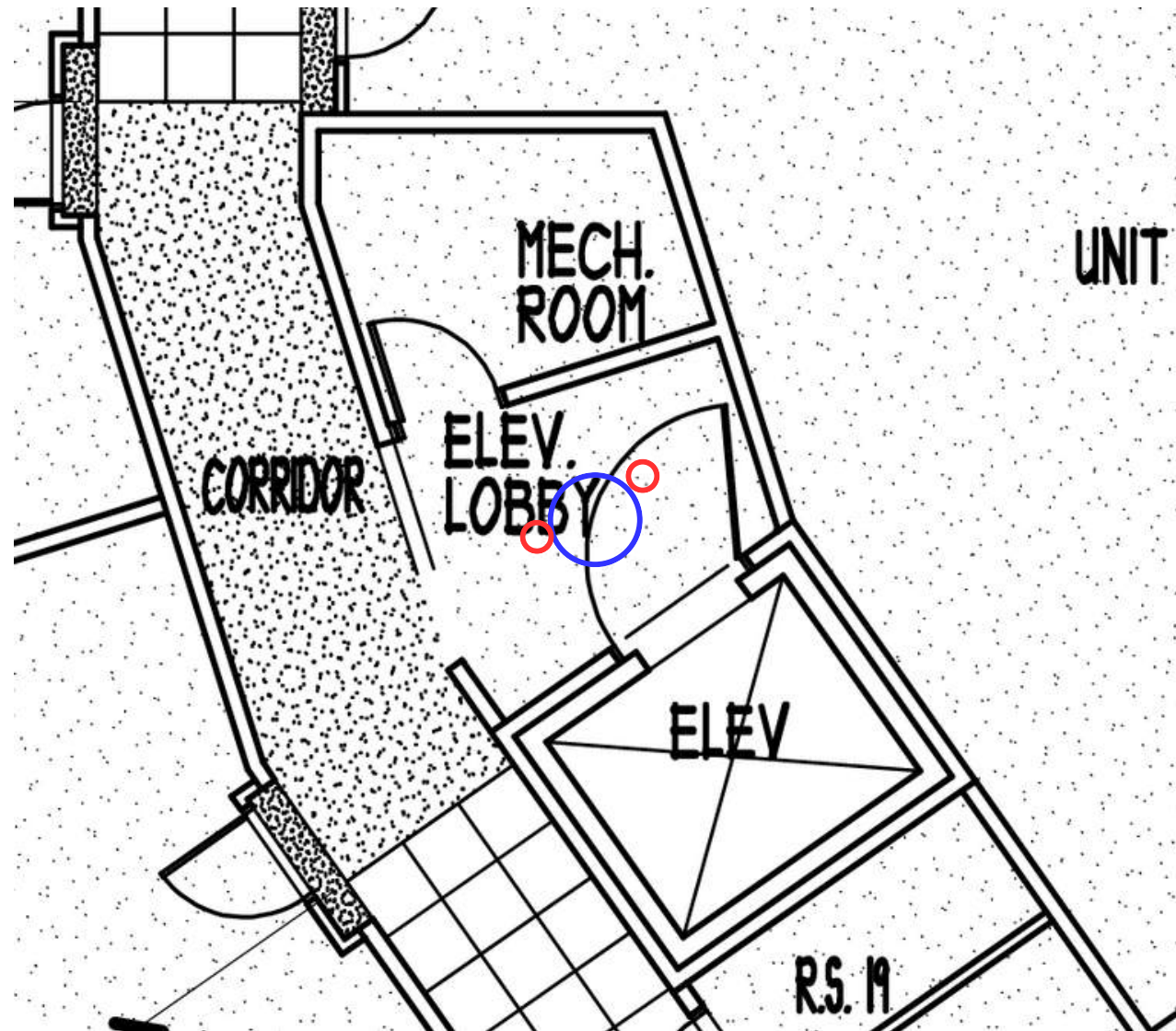

FLUSH MOUNT
OPTION

L4



RECESSED
OPTION

UNIT ENTRY SCONCES



L13

UNIT PENDANTS

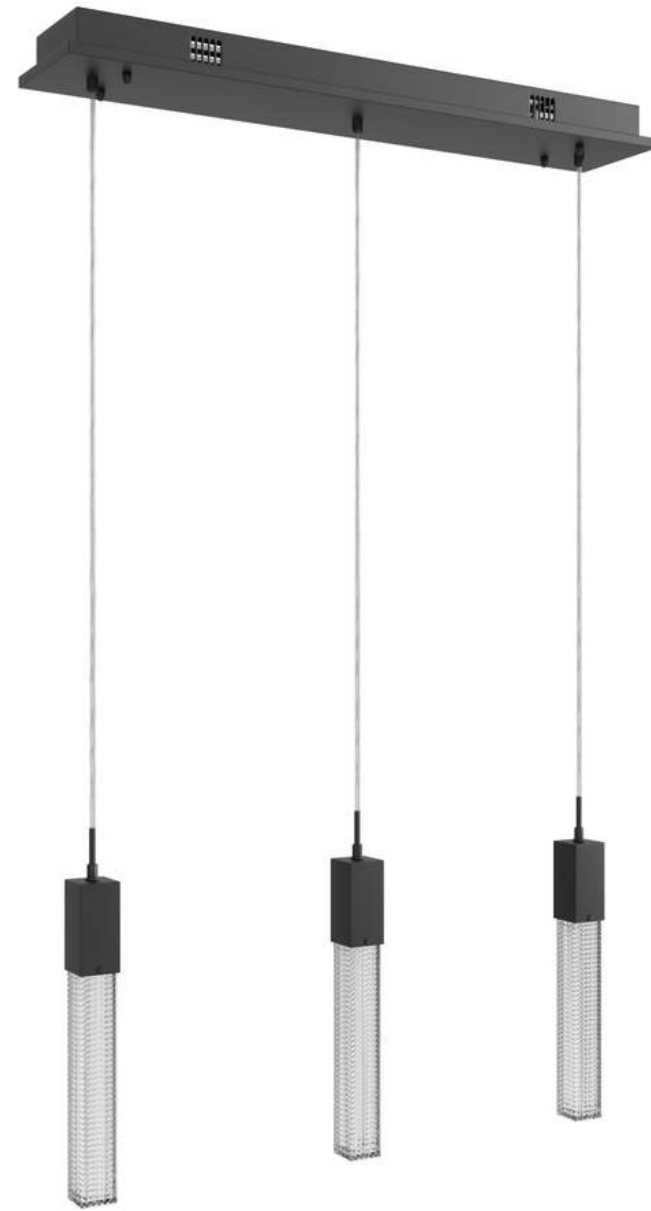

L14

UNIT RESTROOMS



L14

UNIT OVERALL CEILING

L12



FLUSH MOUNT

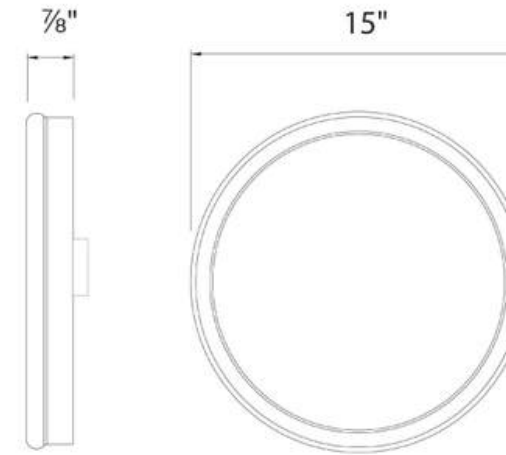

FM-4615

L4



RECESSED

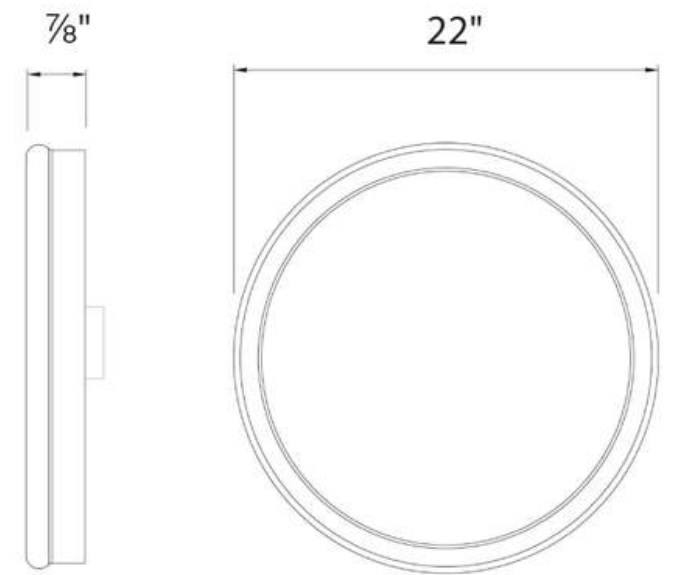

FM-4622

SIZES

